

IFC CAMPUS MAFRA  
 ANTEPROJETO  
 ARQUITETÔNICO  
 BLOCO A - ADMINISTRATIVO  
 PLANTA PAVIMENTO  
 ESCALA: 1/50  
 RUA 25 DE MARÇO, FAXINAL, MAFRA, SC  
 ARQ. URB. MARCELO BRADACZ LOPES  
 V00 - 05/07/2024

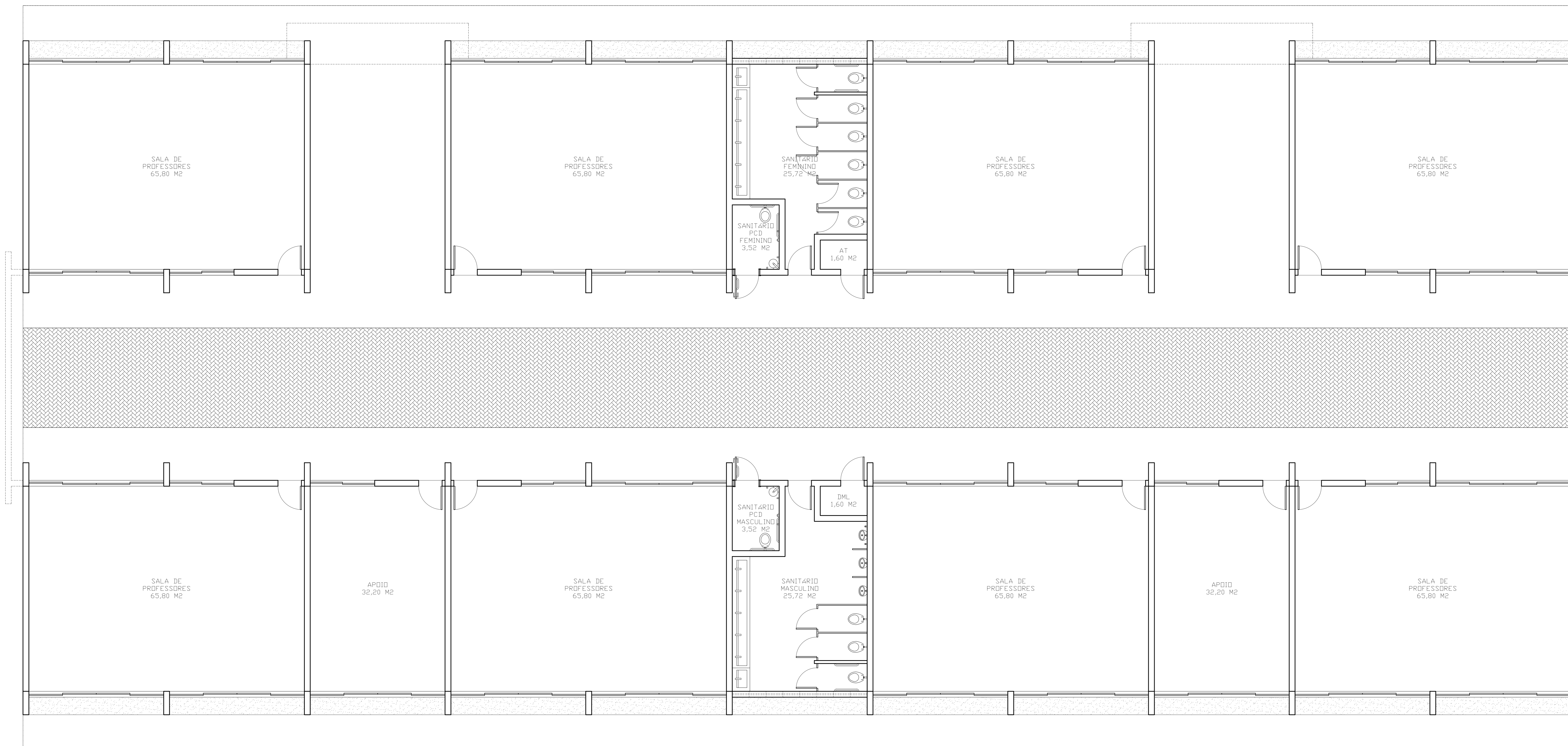

IFC CAMPUS MAFRA  
 ANTEPROJETO  
 ARQUITETÔNICO  
 BLOCO B - PROFESSORES  
 PLANTA PAVIMENTO  
 ESCALA: 1/50  
 RUA 25 DE MARÇO, FAXINAL, MAFRA, SC  
 ARQ. URB. MARCELO BRADACZ LOPES  
 V00 - 05/07/2024

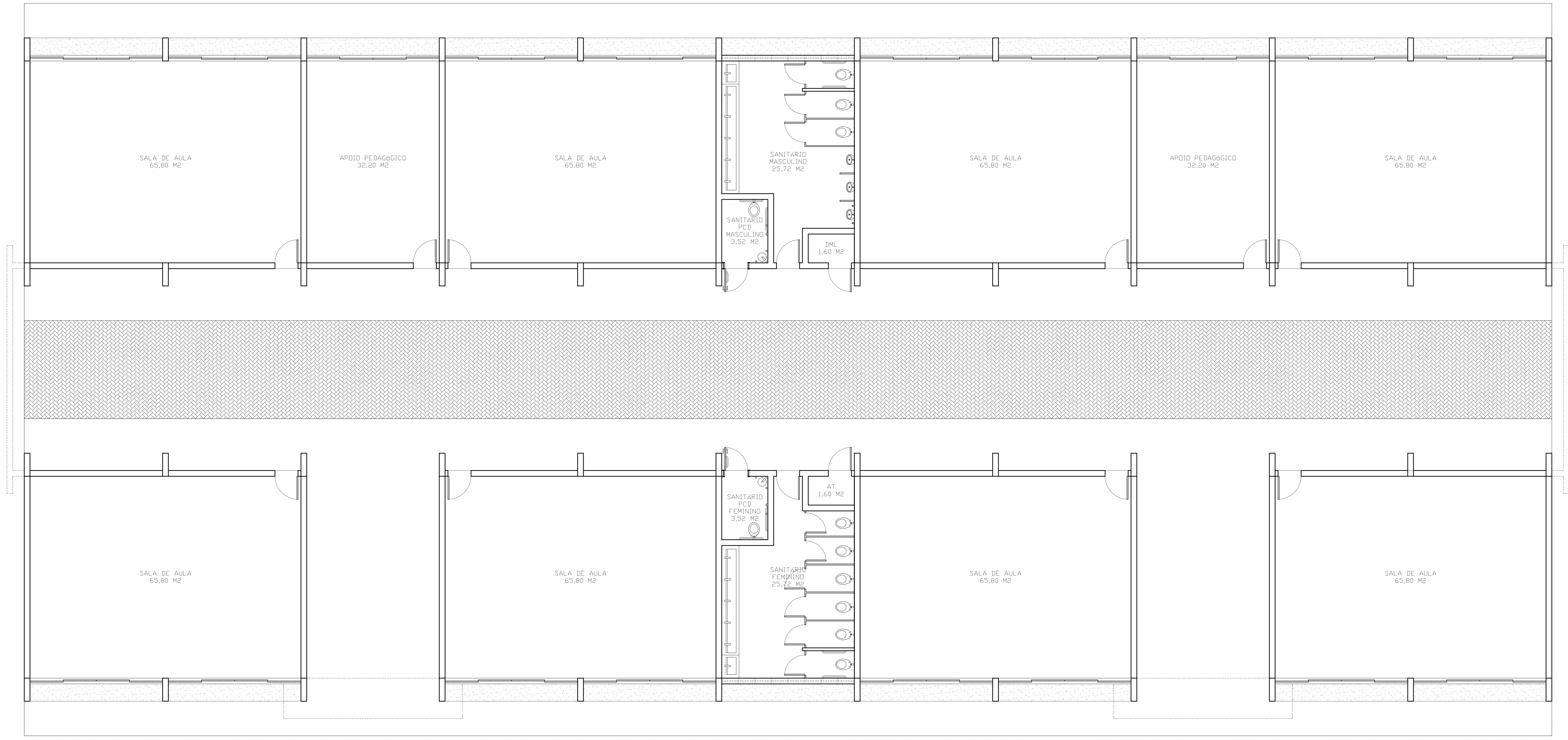

IFC CAMPUS MAFRA  
 ANTEPROJETO  
 ARQUITETÔNICO  
 BLOCO C - PEDAGÓGICO SALAS DE AULA  
 PLANTA PAVIMENTO  
 ESCALA: 1/50  
 RUA 25 DE MARÇO, FAXINAL, MAFRA, SC  
 ARQ. URB. MARCELO BRADACZ LOPES  
 V00 - 05/07/2024

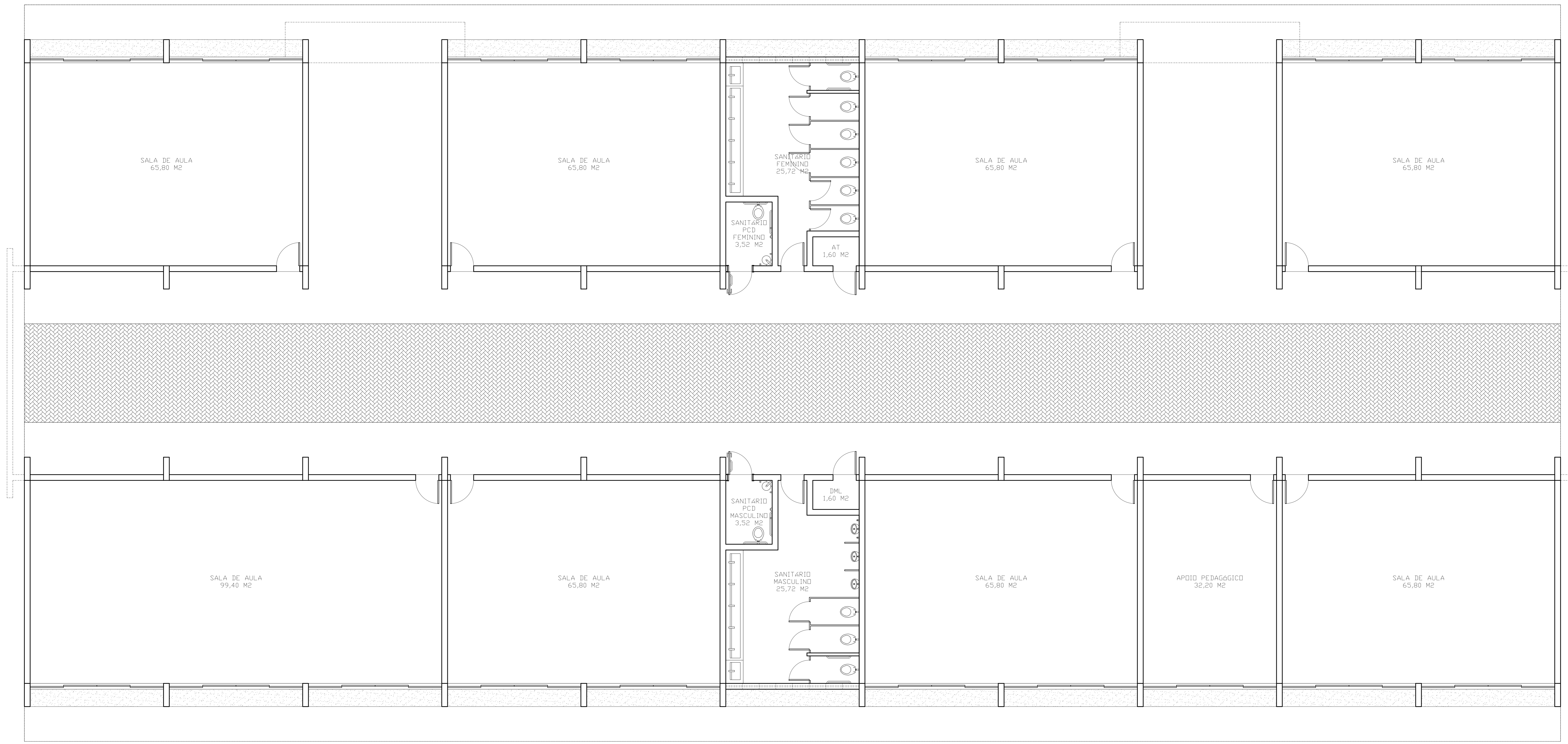

IFC CAMPUS MAFRA  
 ANTEPROJETO  
 ARQUITETÔNICO  
 BLOCO D - PEDAGÓGICO SALAS DE AULA  
 PLANTA PAVIMENTO  
 ESCALA: 1/50  
 RUA 25 DE MARÇO, FAXINAL, MAFRA, SC  
 ARQ. URB. MARCELO BRADACZ LOPES  
 V00 - 05/07/2024

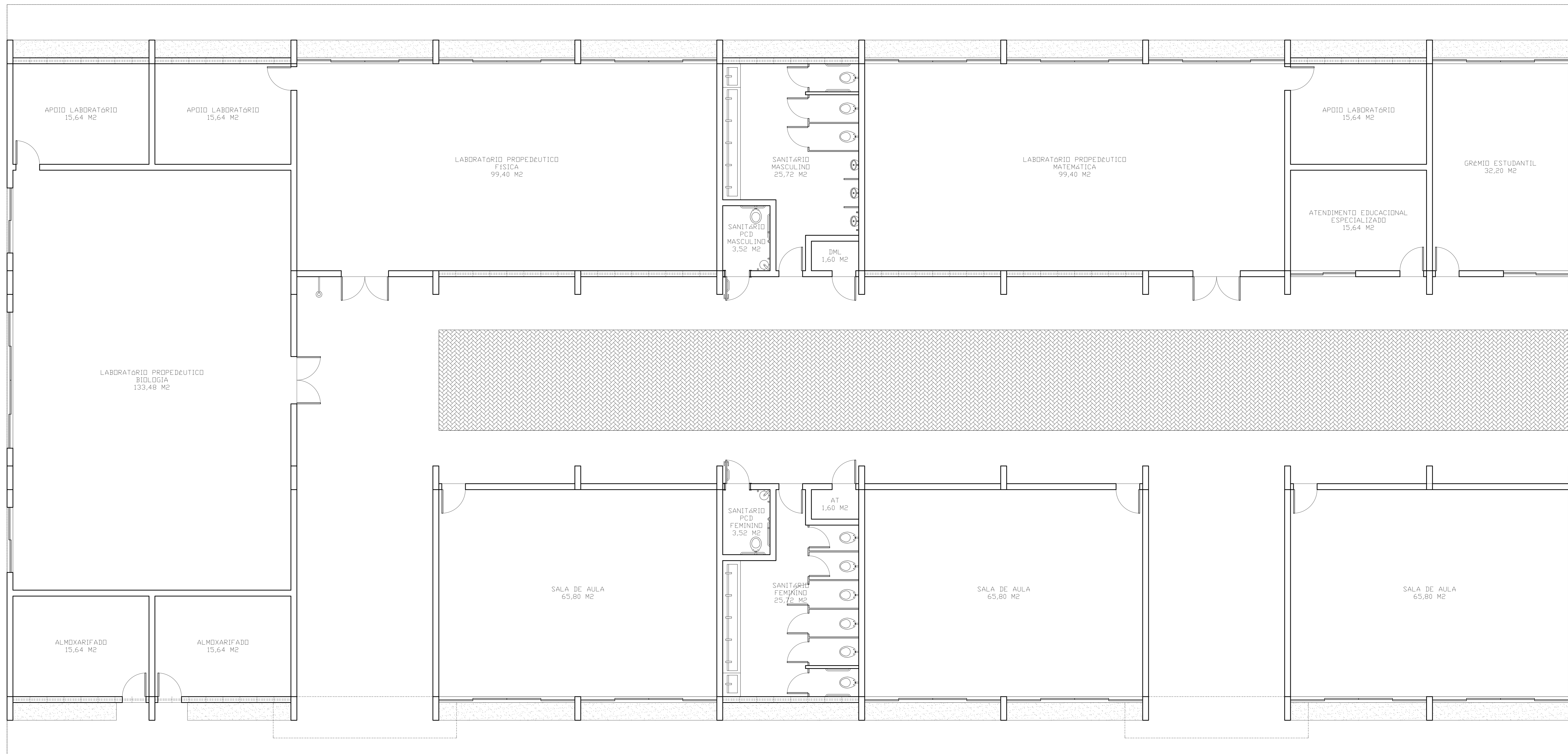

IFC CAMPUS MAFRA  
 ANTEPROJETO  
 ARQUITETÔNICO  
 BLOCO E - PEDAGÓGICO LABORATÓRIOS PROPEDEUTICOS  
 PLANTA PAVIMENTO  
 ESCALA: 1/50  
 RUA 25 DE MARÇO, FAXINAL, MAFRA, SC  
 ARQ. URB. MARCELO BRADACZ LOPES  
 V00 - 05/07/2024

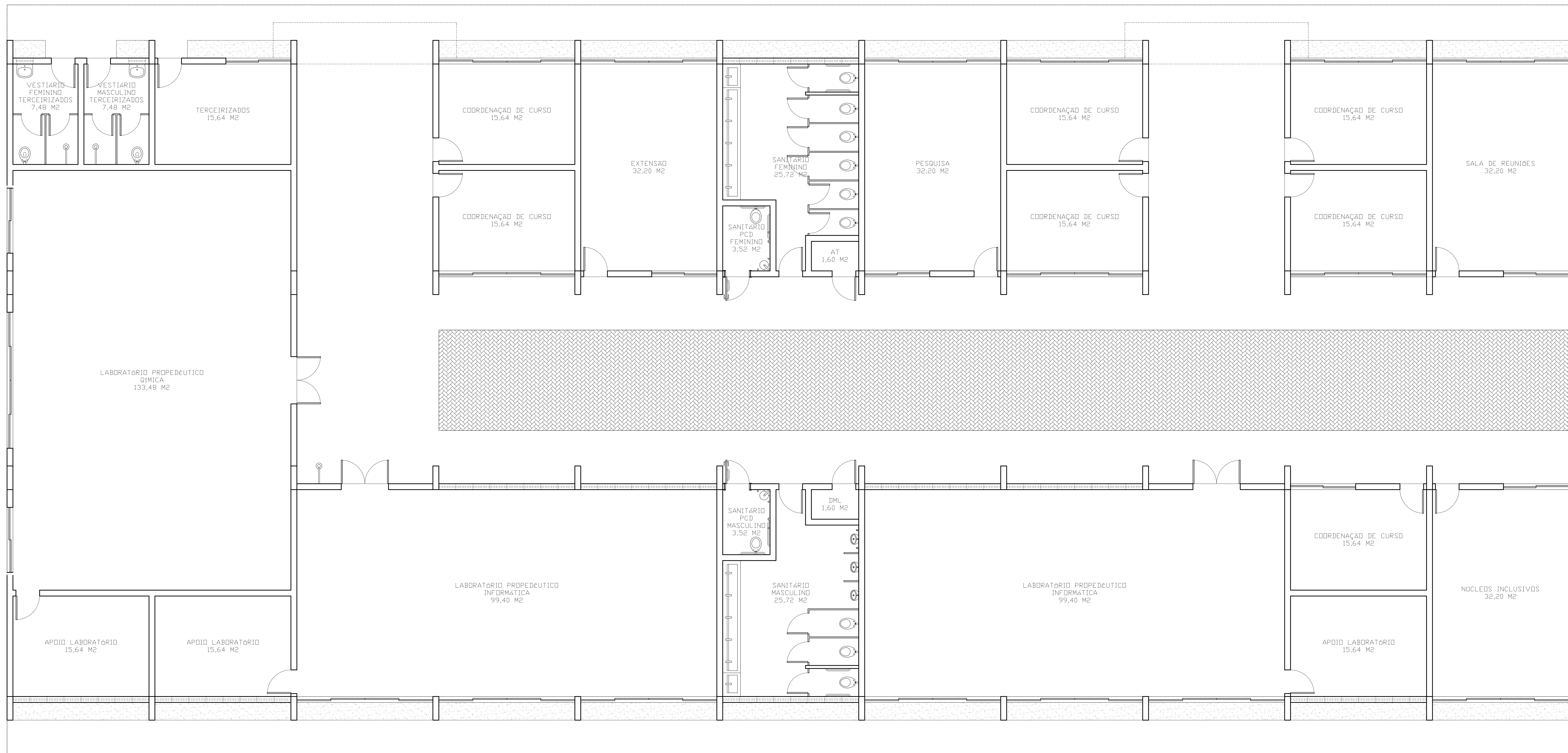

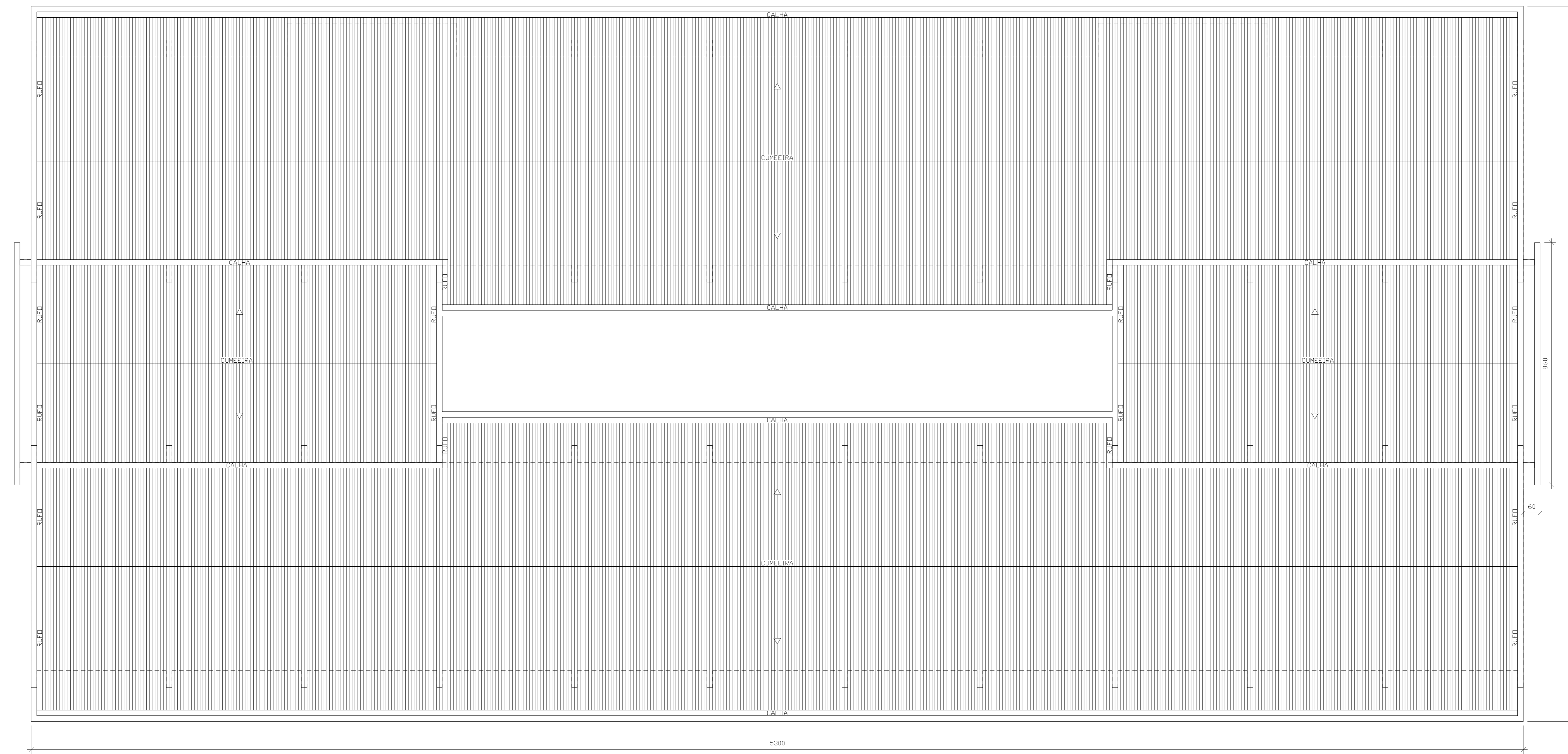

BLOCOS A, B, C e D

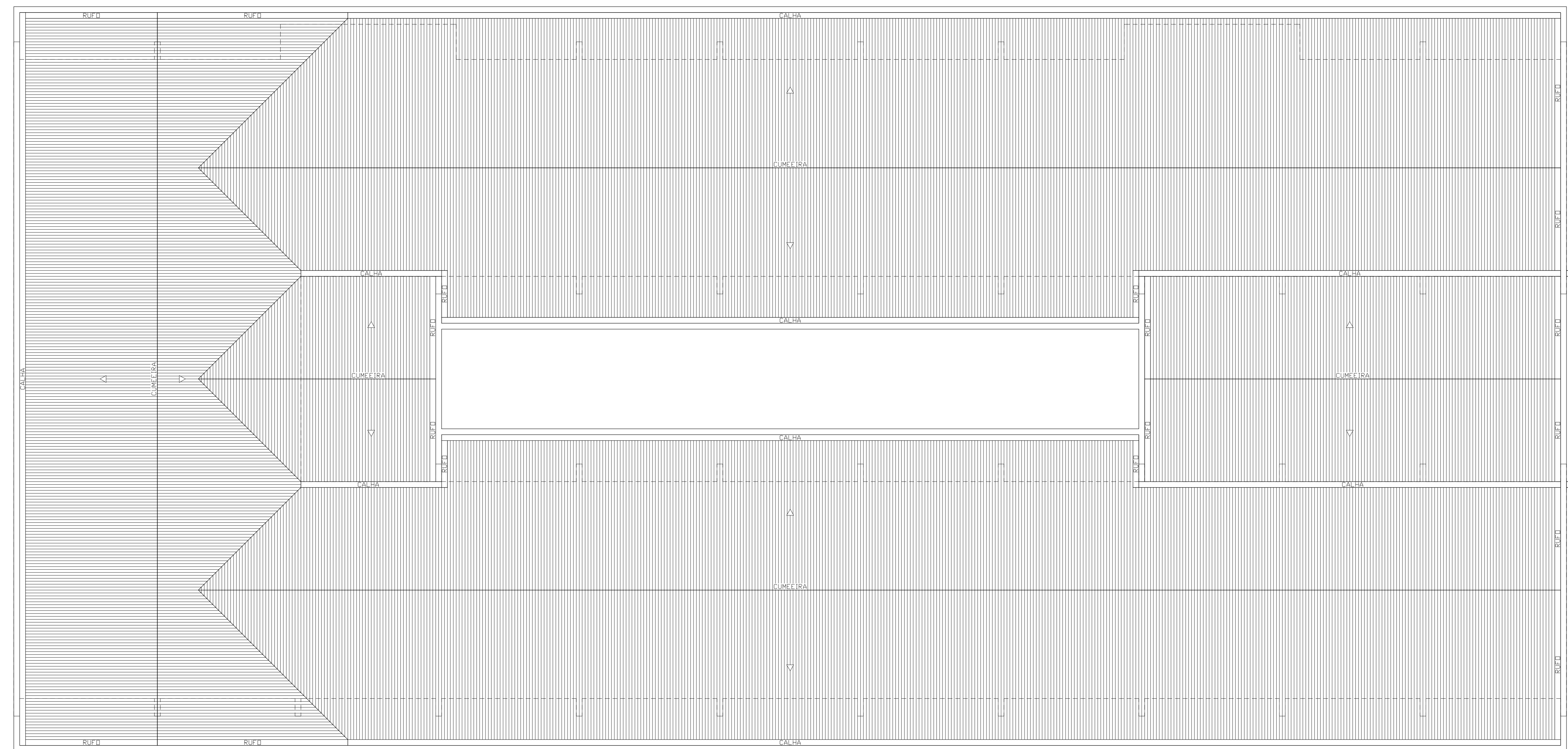

BLOCOS E e F

IFC CAMPUS MAFRA  
 ANTEPROJETO  
 ARQUITETÔNICO  
 BLOCOS A, B, C, D, E E F  
 PLANTA COBERTURA  
 ESCALA: 1/75  
 RUA 25 DE MARÇO, FAXINAL, MAFRA, SC  
 ARQ. URB. MARCELO BRADACZ LOPES  
 V00 - 05/07/2024

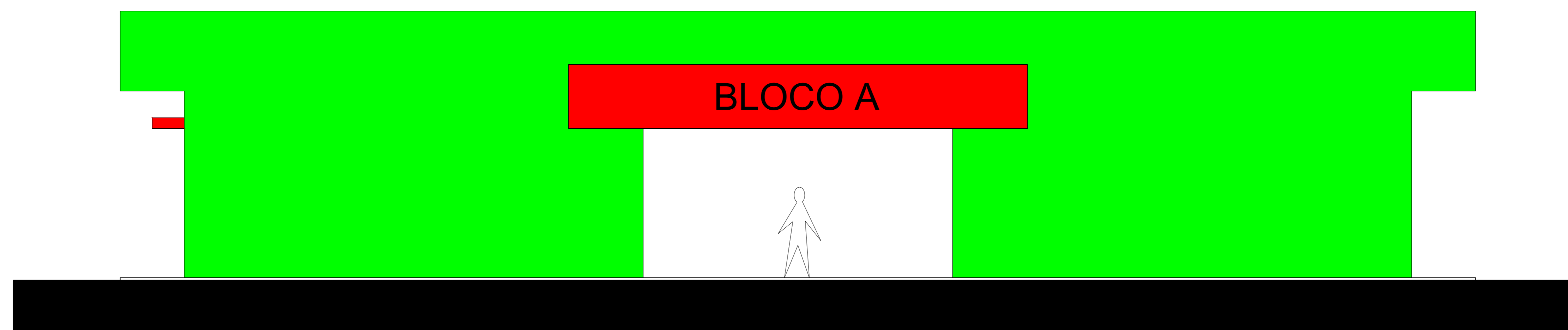
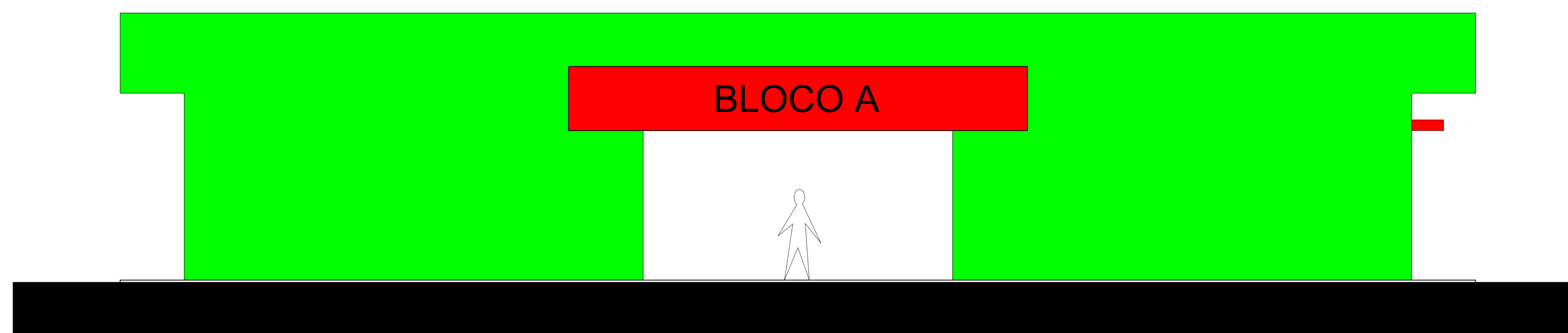
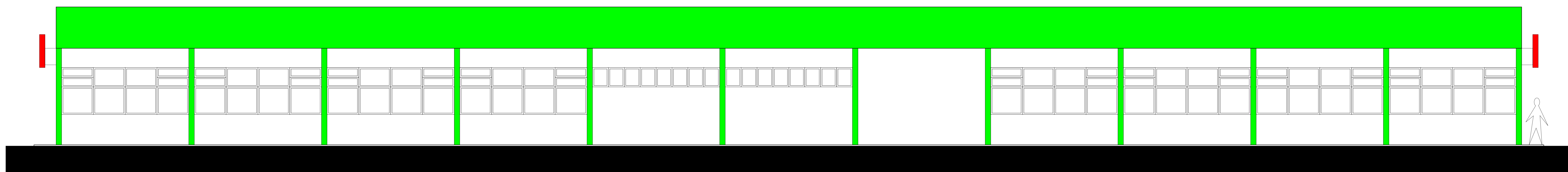
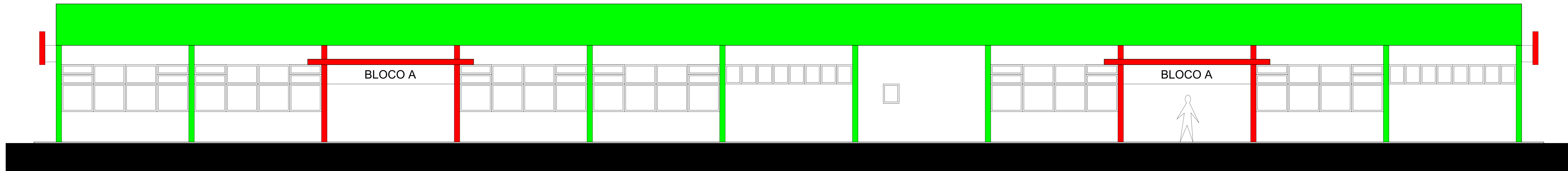



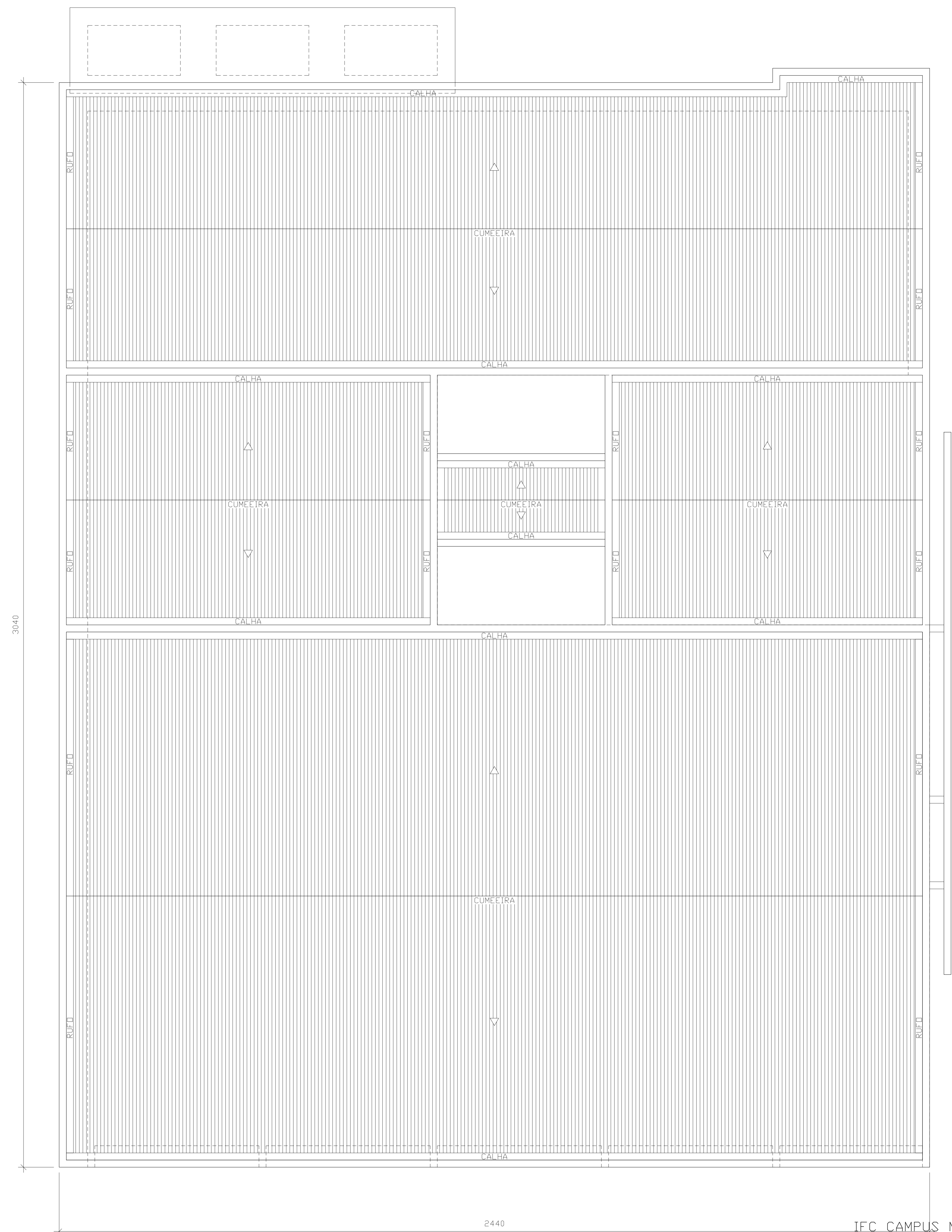
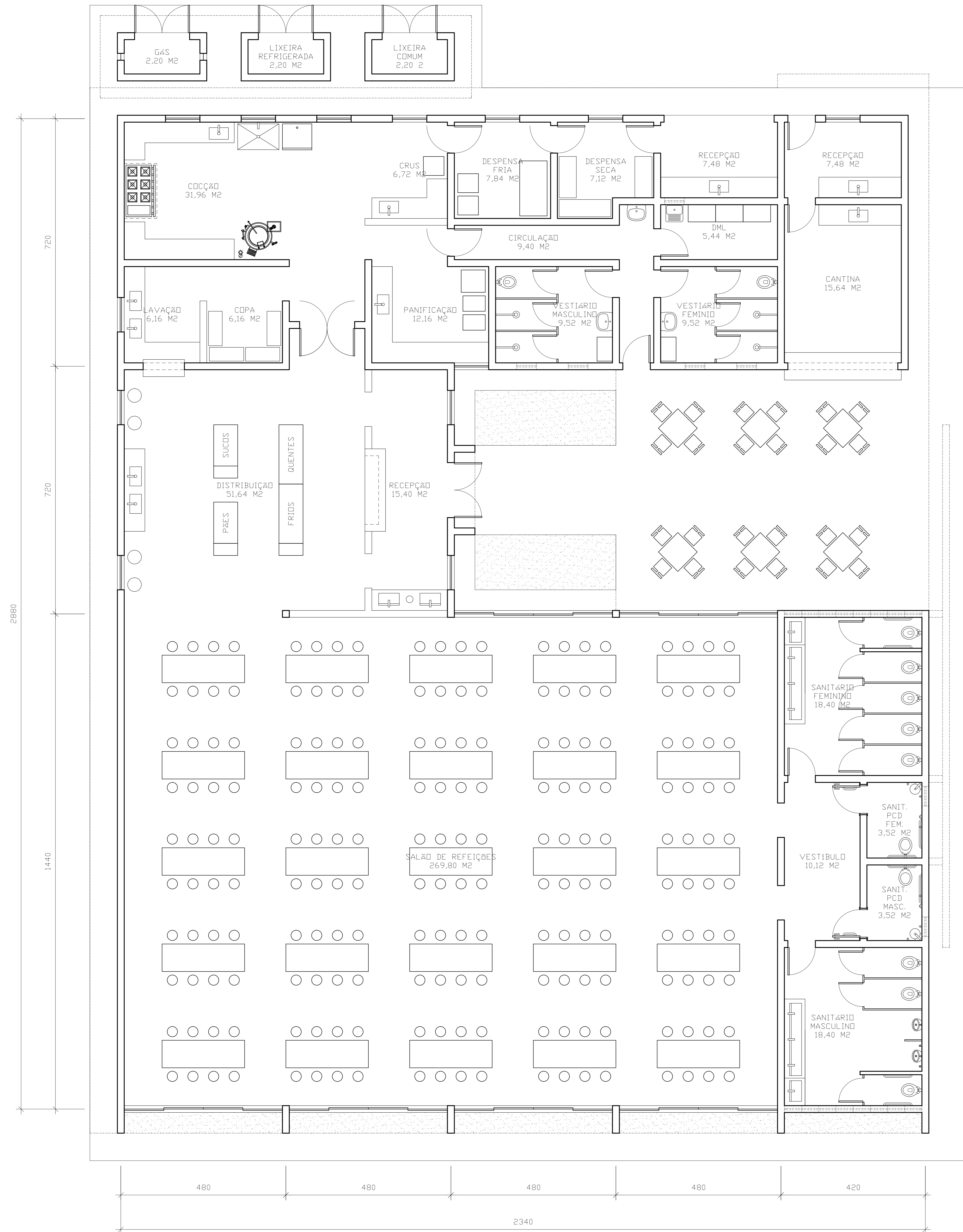

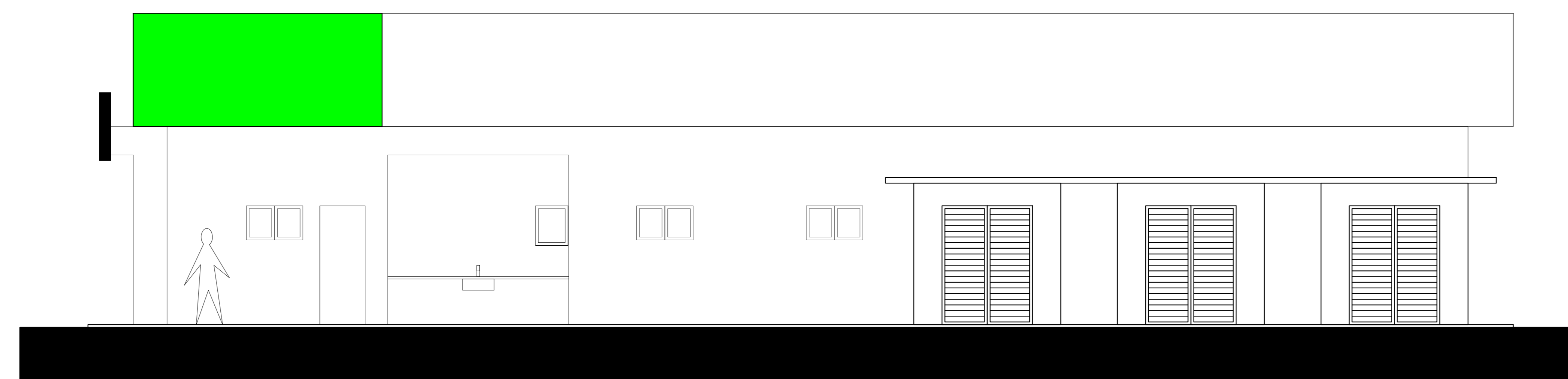
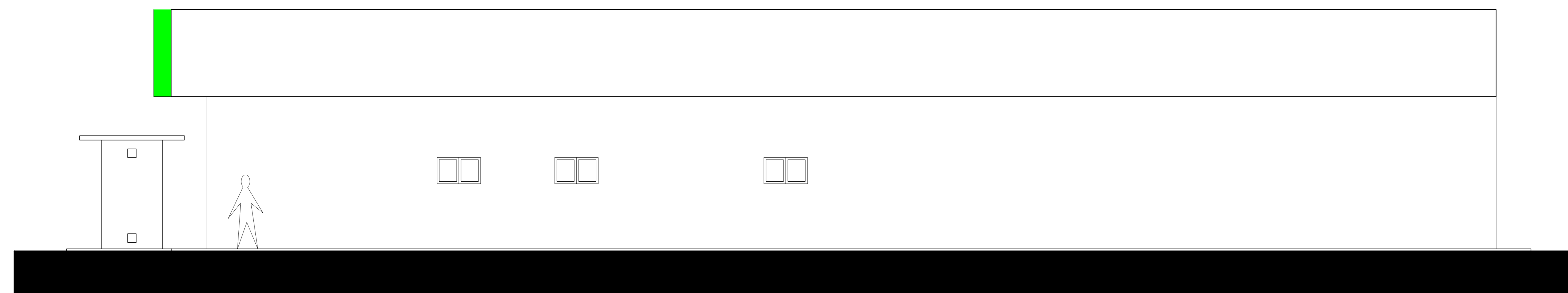

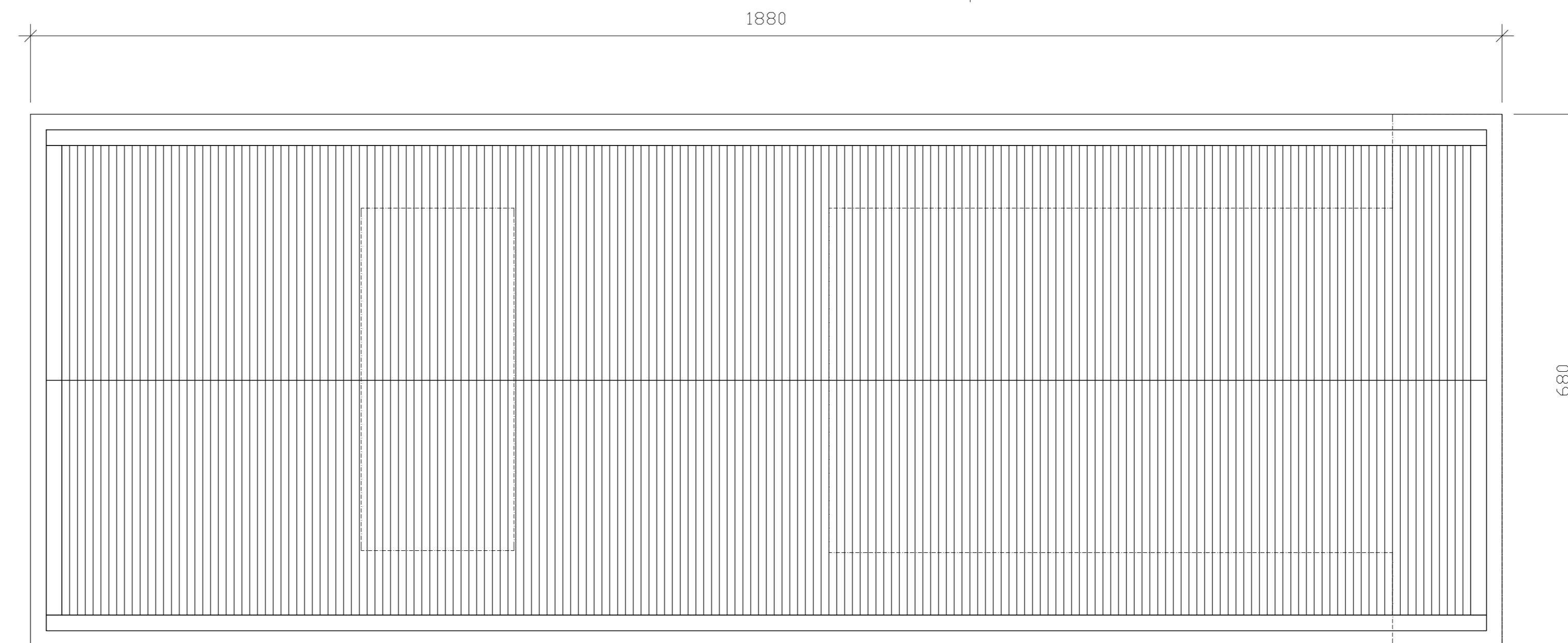
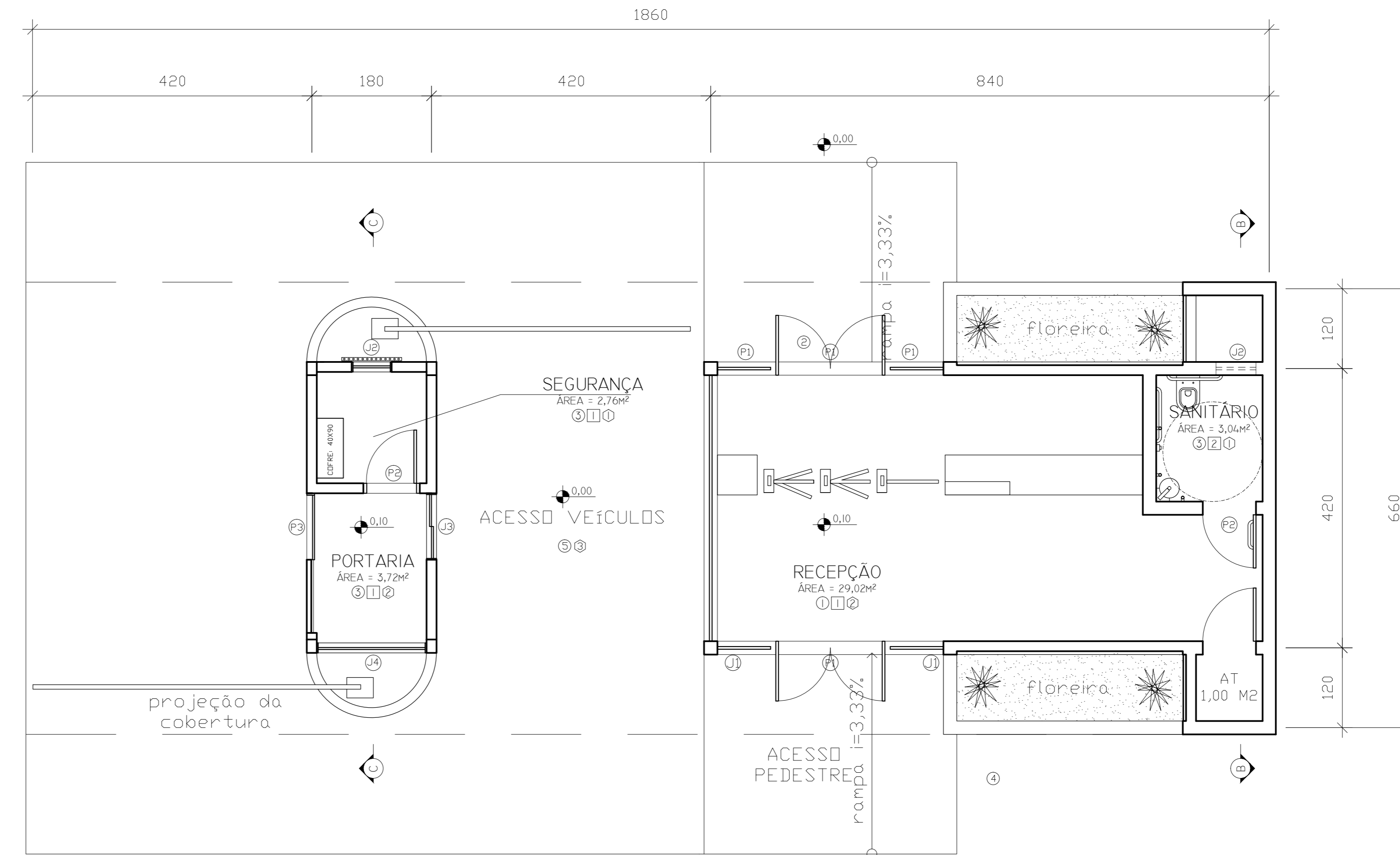
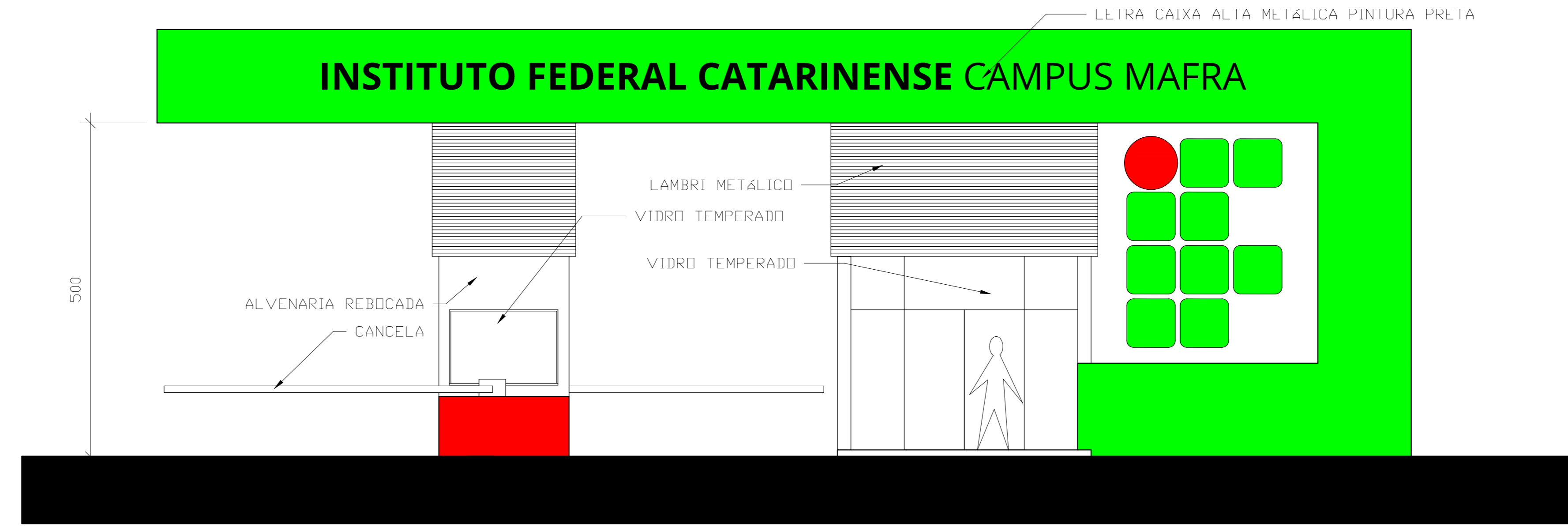
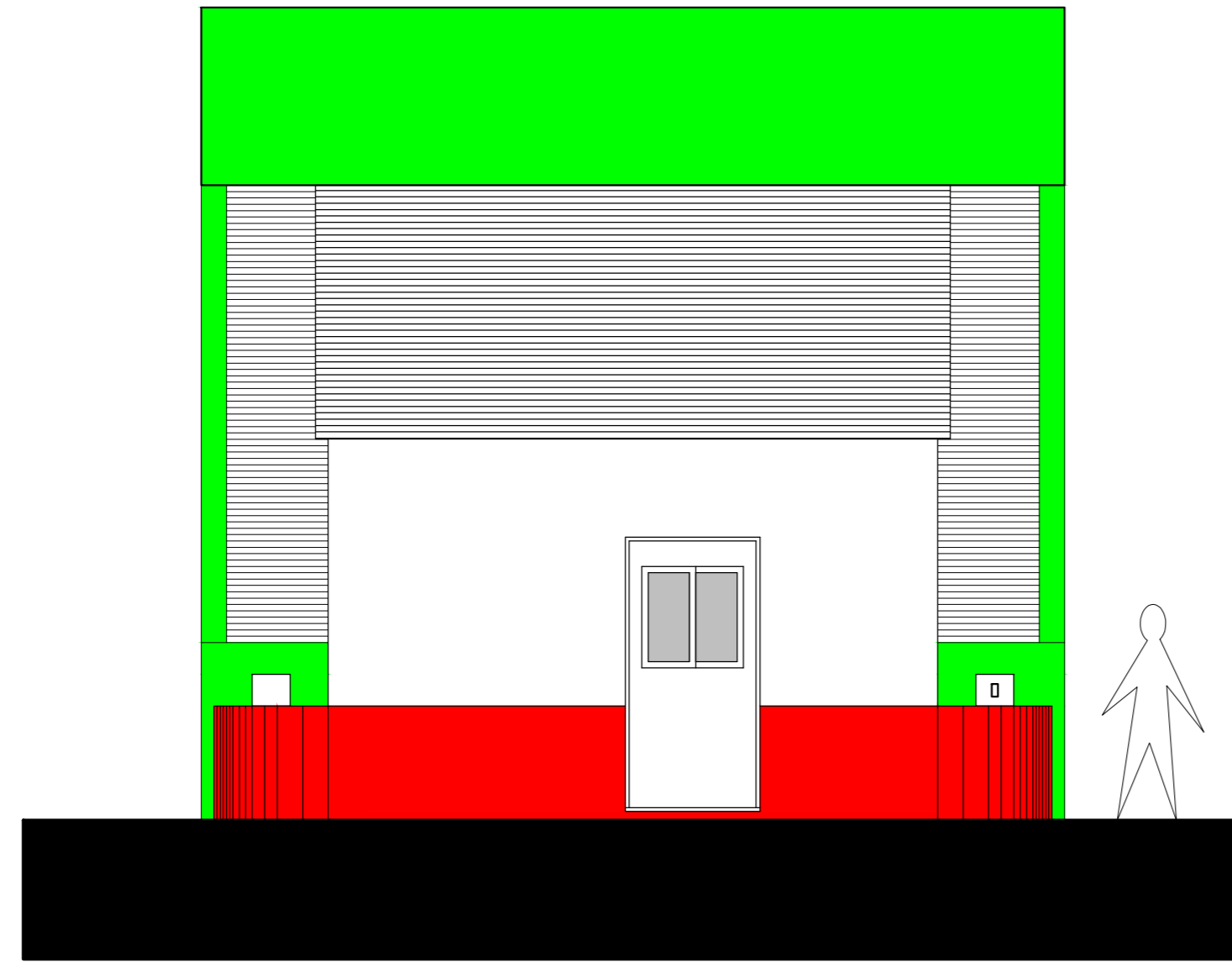
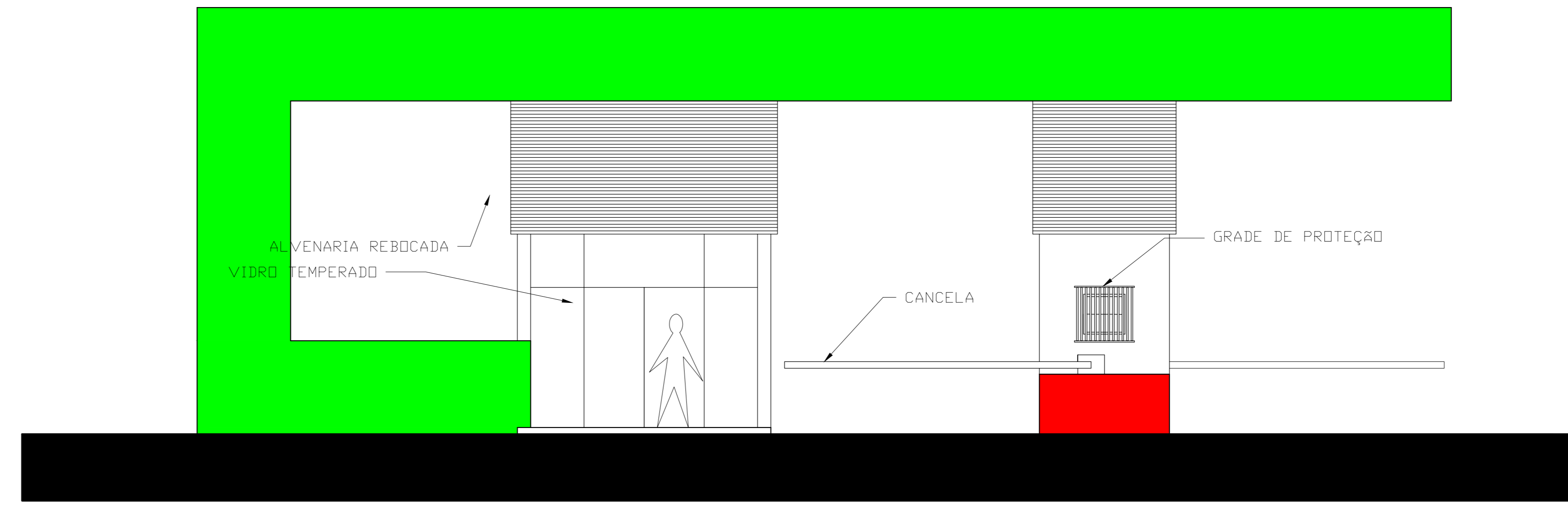
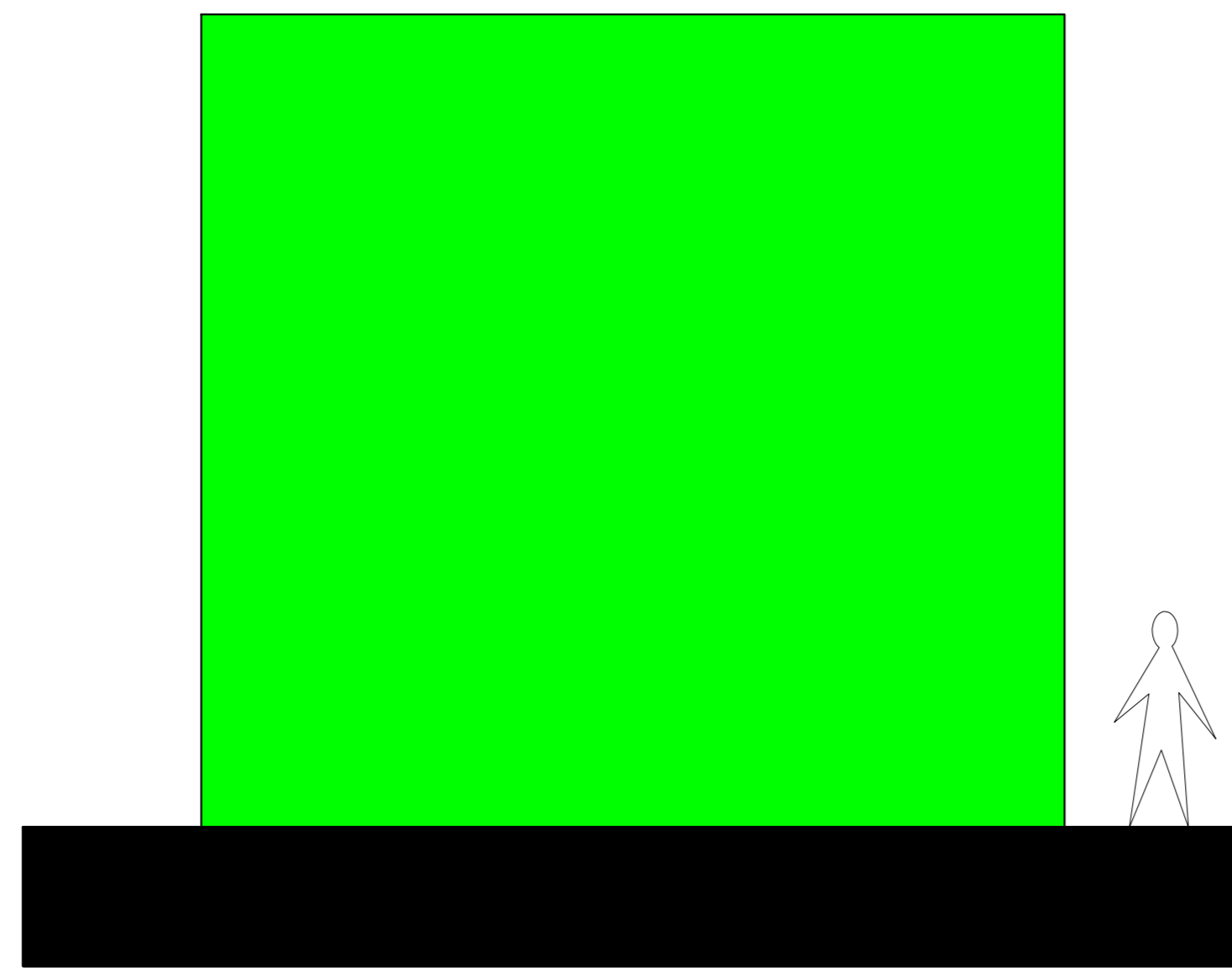

IFC CAMPUS MAFRA  
 ANTEPROJETO  
 ARQUITETÔNICO  
 GUARITA E RECEPÇÃO  
 PLANTAS PAVIMENTO E COBERTURA E FACHADAS  
 ESCALA: 1/50  
 RUA 25 DE MARÇO, FAXINAL, MAFRA, SC  
 ARQ. URB. MARCELO BRADACZ LOPES  
 V00 - 05/07/2024



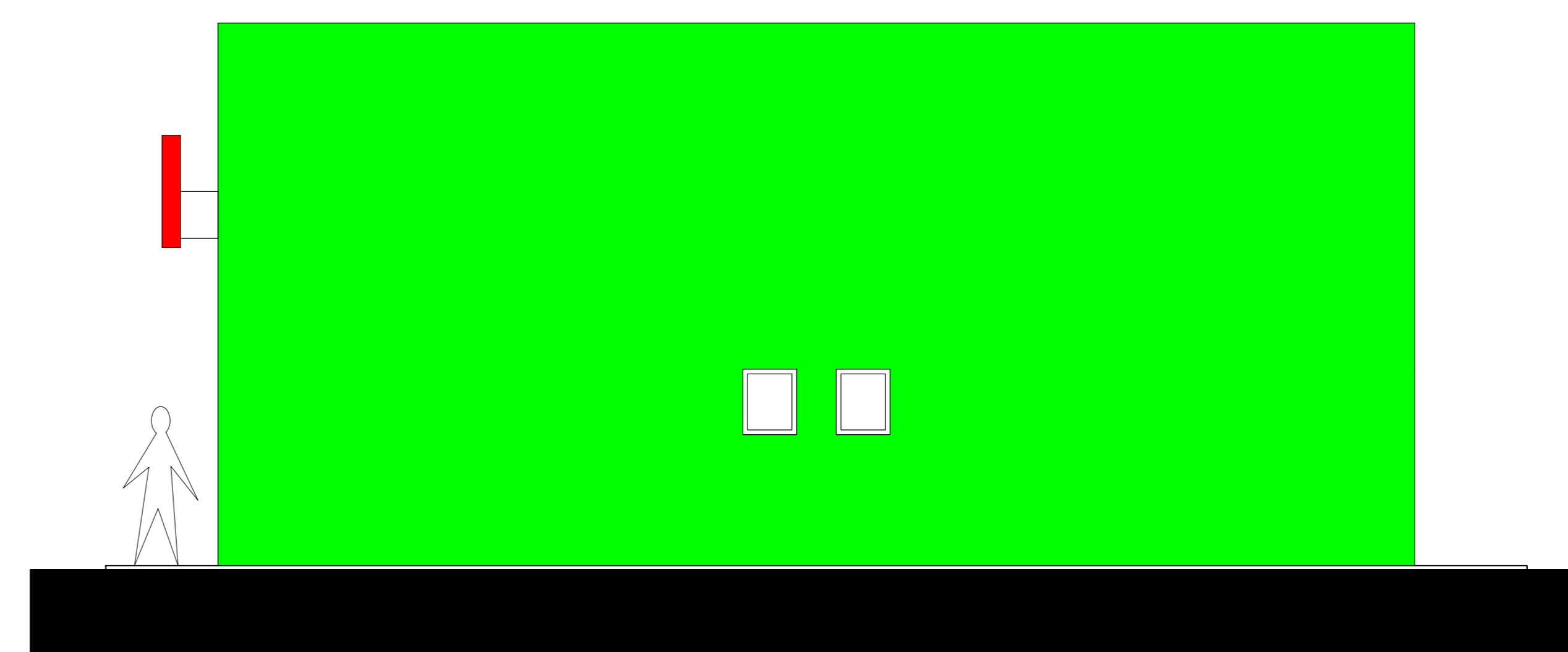
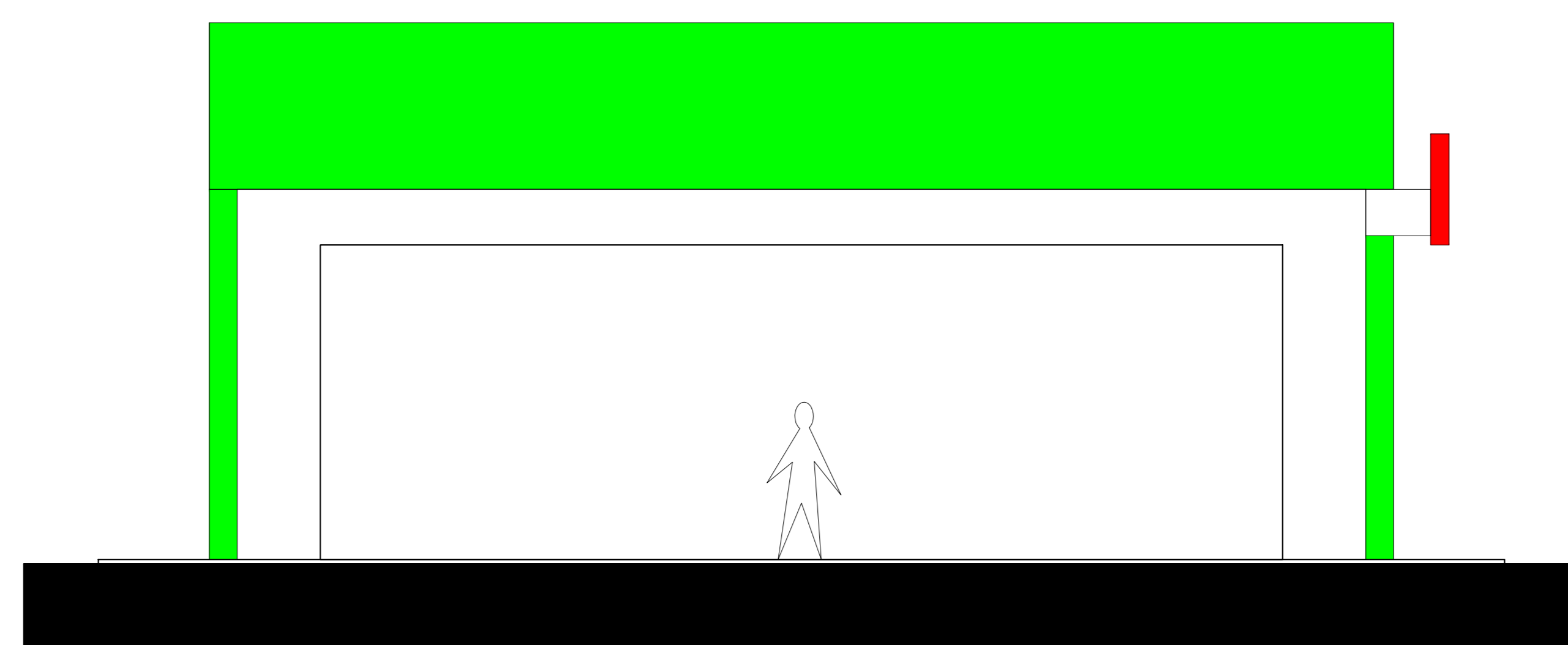

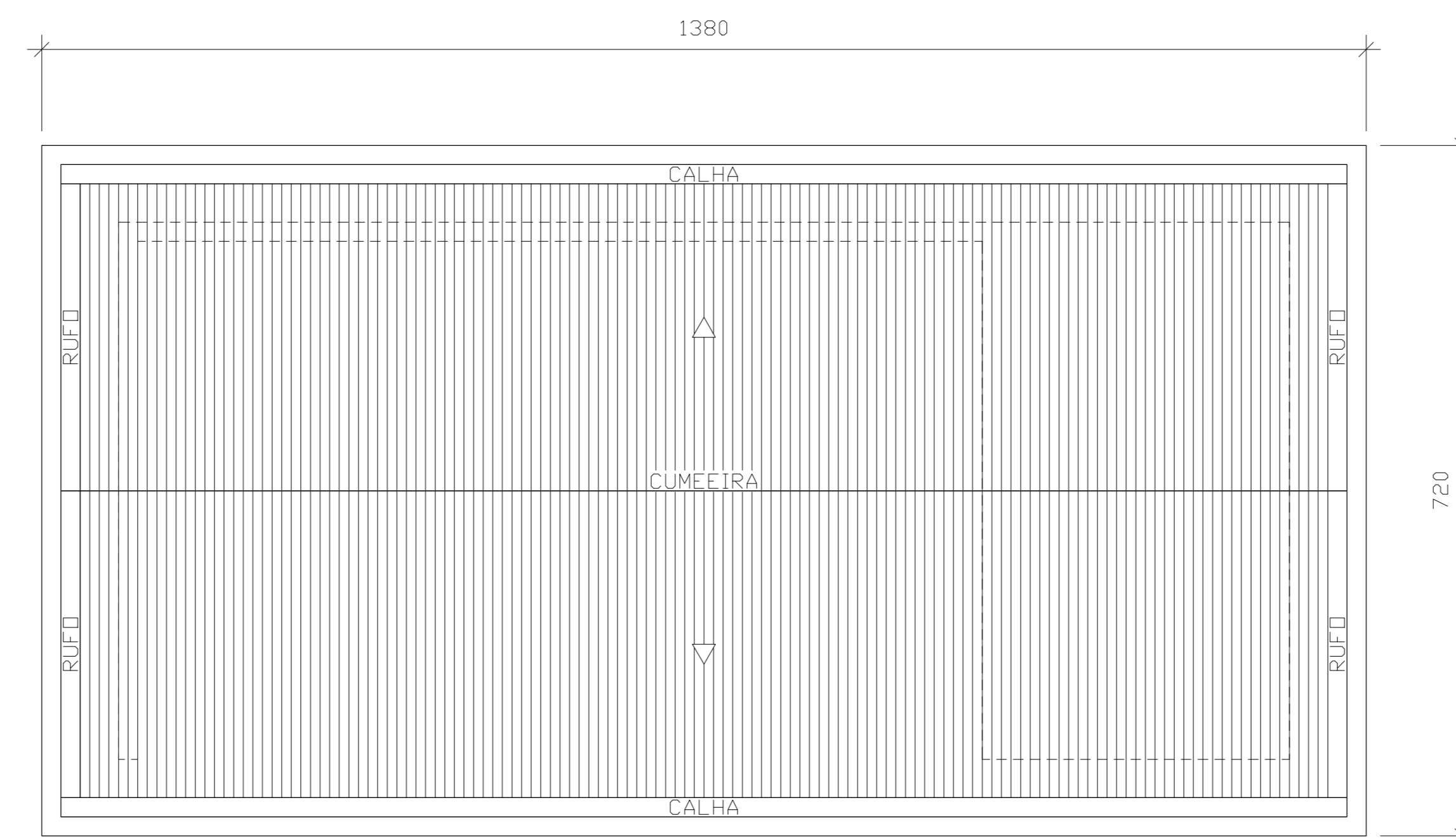
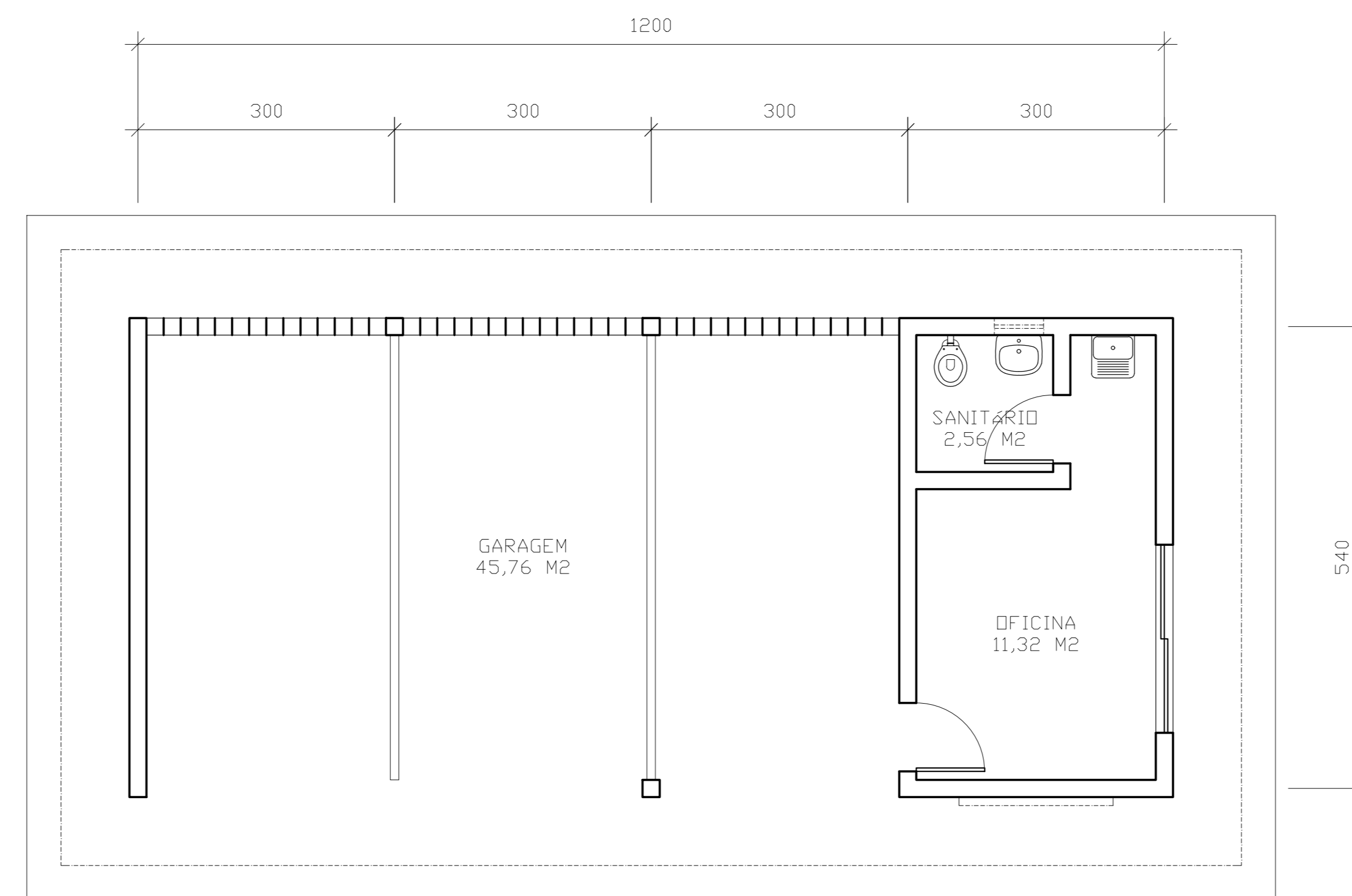
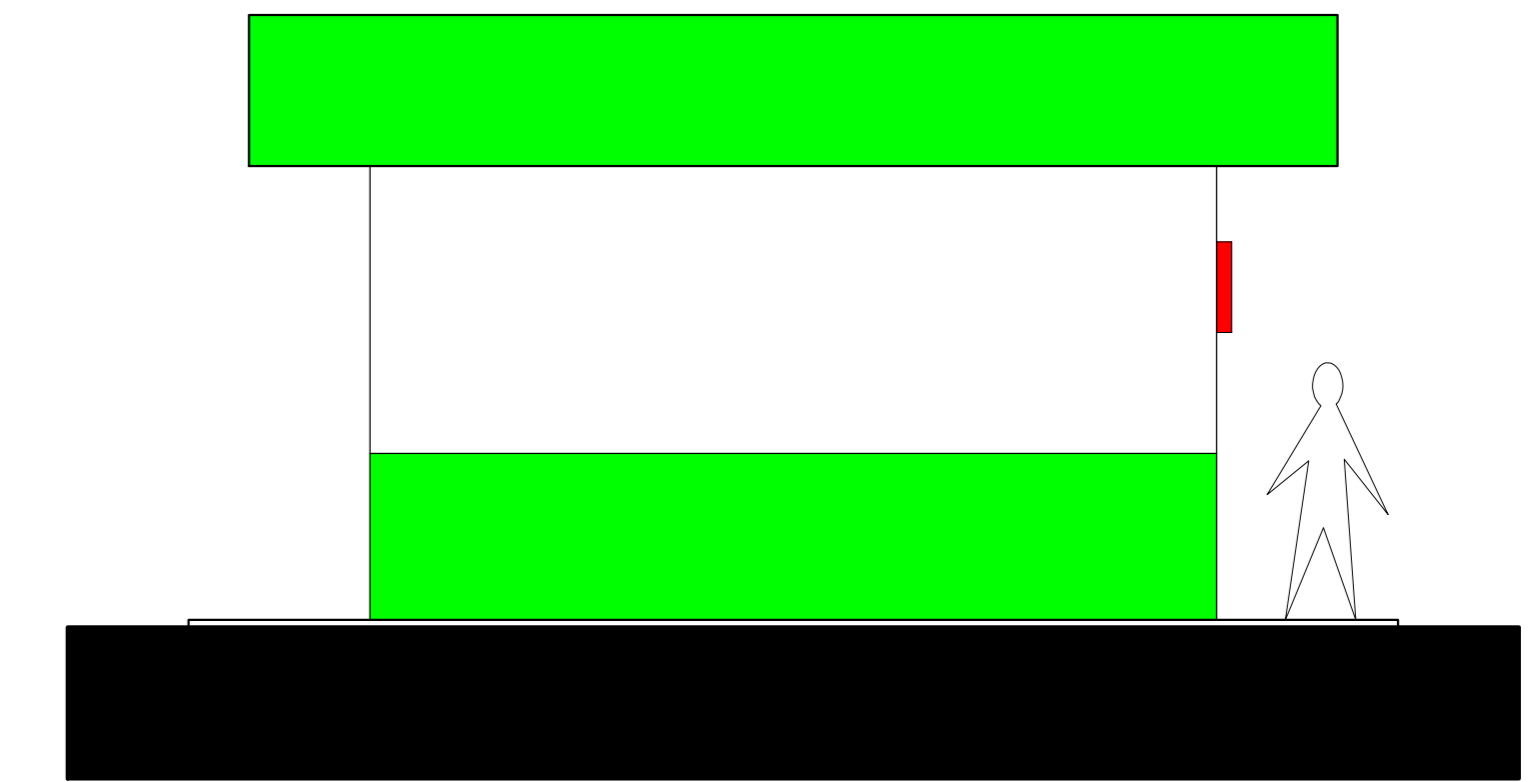
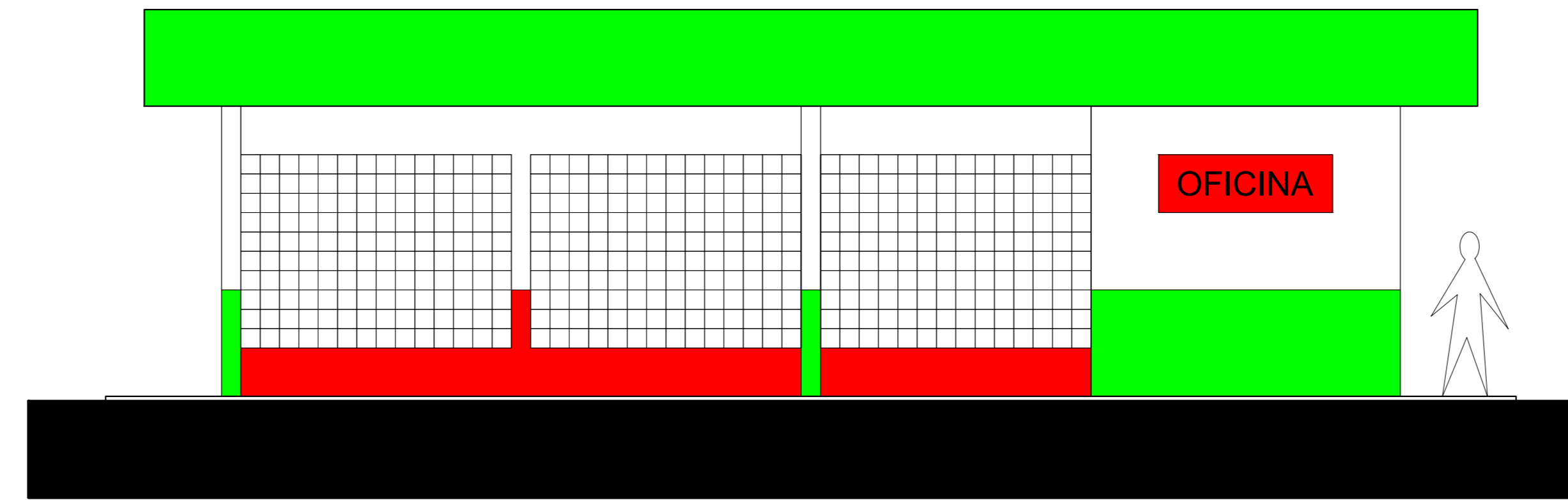
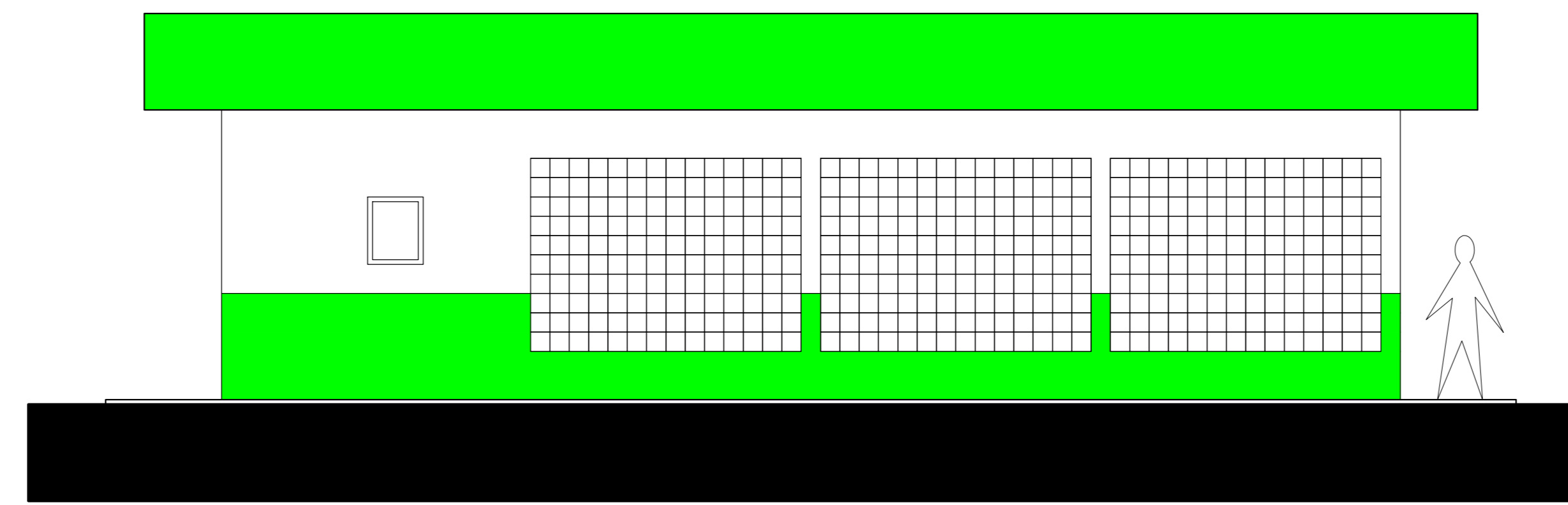
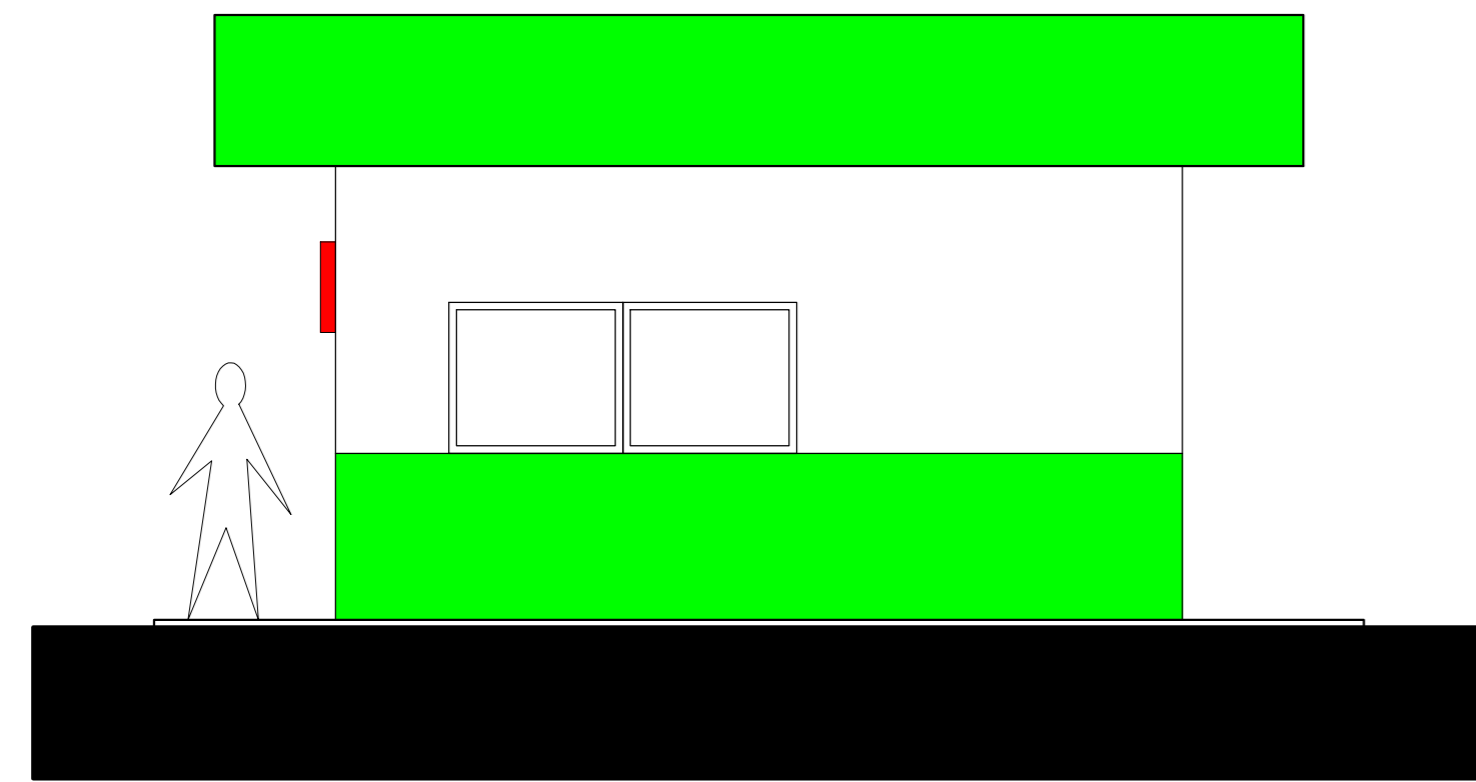

IFC CAMPUS MAFRA  
 ANTEPROJETO  
 ARQUITETÔNICO  
 GARAGEM  
 PLANTAS PAVIMENTO E COBERTURA E FACHADAS  
 ESCALA: 1/50  
 RUA 25 DE MARÇO, FAXINAL, MAFRA, SC  
 ARQ. URB. MARCELO BRADACZ LOPES  
 V00 - 05/07/2024

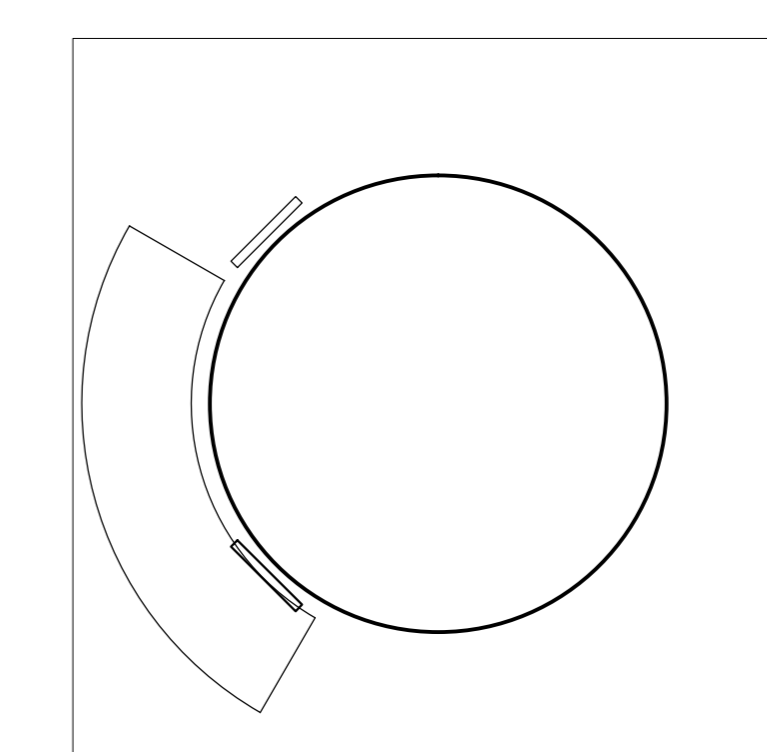
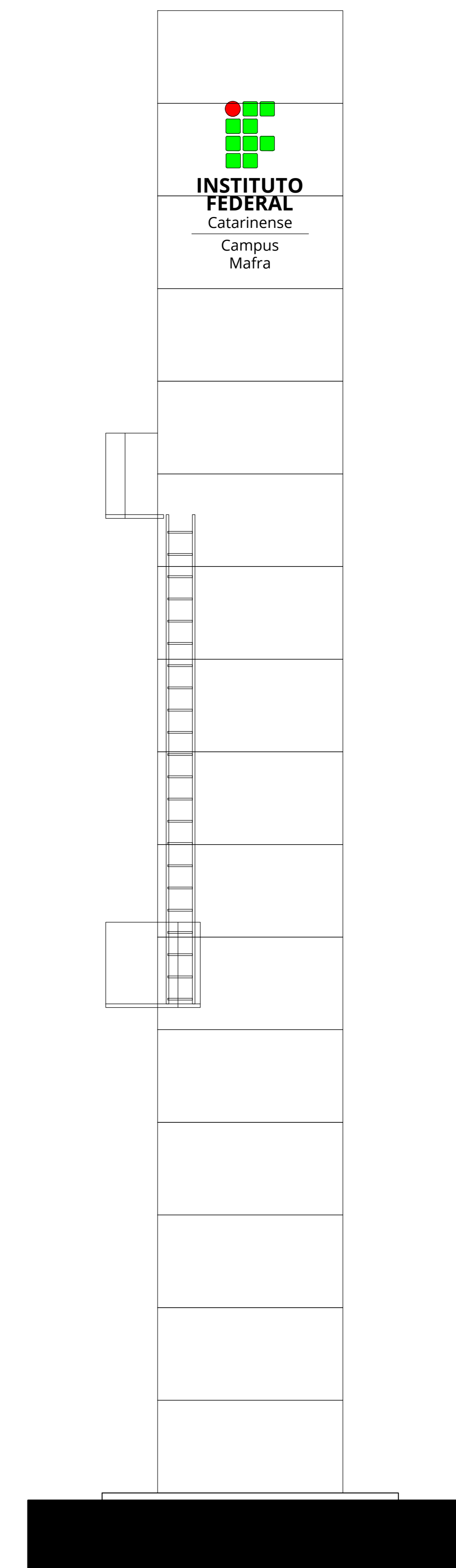
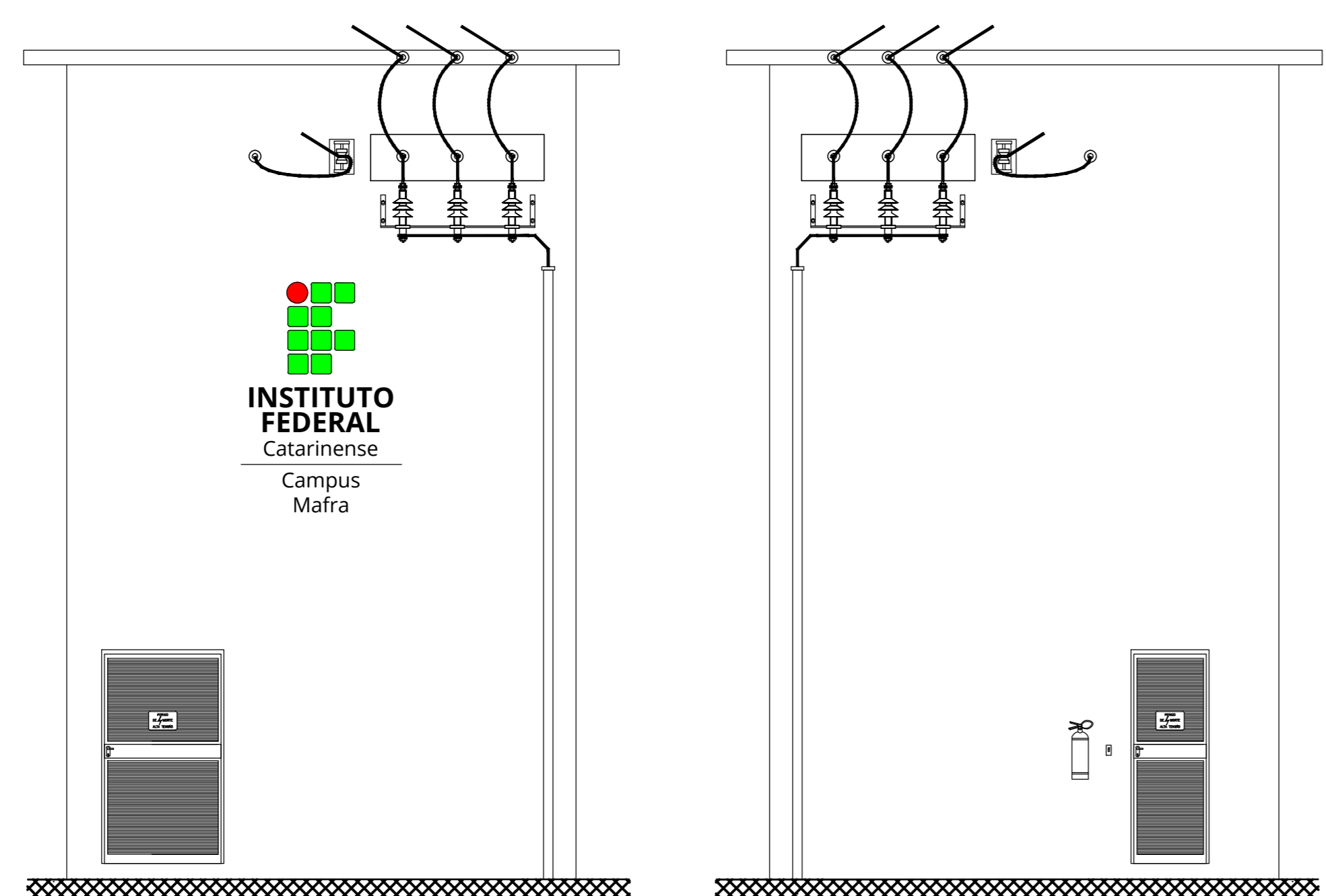
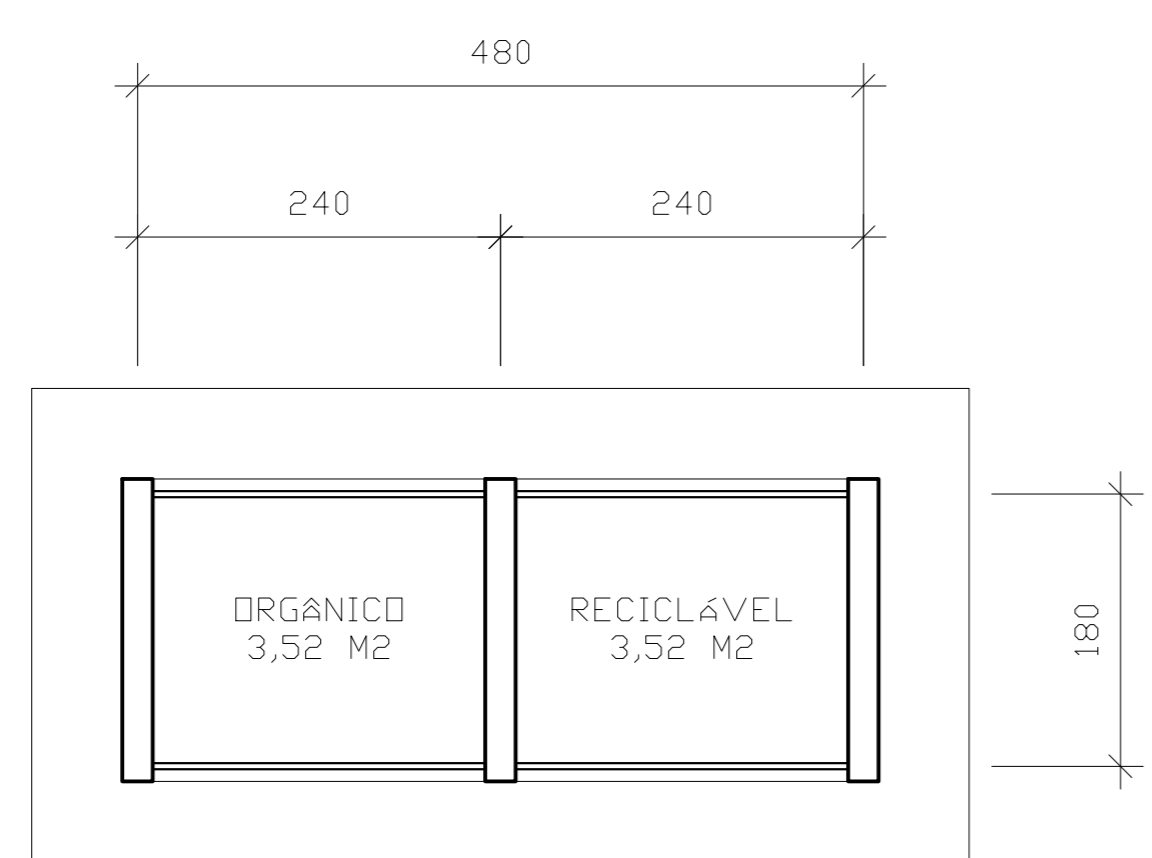
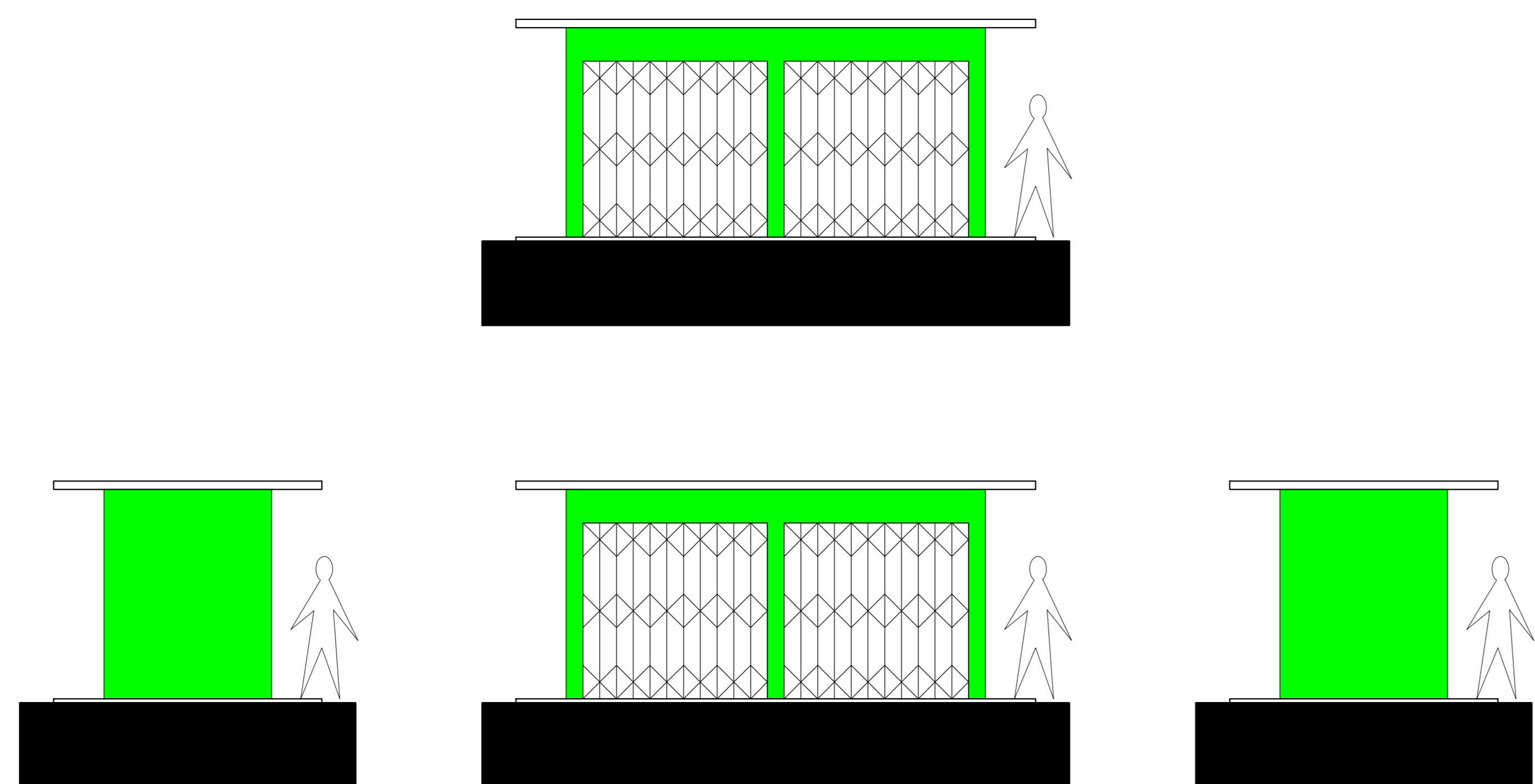

IFC CAMPUS MAFRA  
 ANTEPROJETO  
 ARQUITETÔNICO  
 LIXEIRA, SUBESTAÇÃO E TORRE D'ÁGUA  
 PLANTA PAVIMENTO E FACHADAS  
 ESCALA: 1/50  
 RUA 25 DE MARÇO, FAXINAL, MAFRA, SC  
 ARQ. URB. MARCELO BRADACZ LOPES  
 V00 - 05/07/2024

- LEGENDA
- HIDRÁULICO
  - SANITÁRIO
  - HIDRANTE
  - DRENAGEM

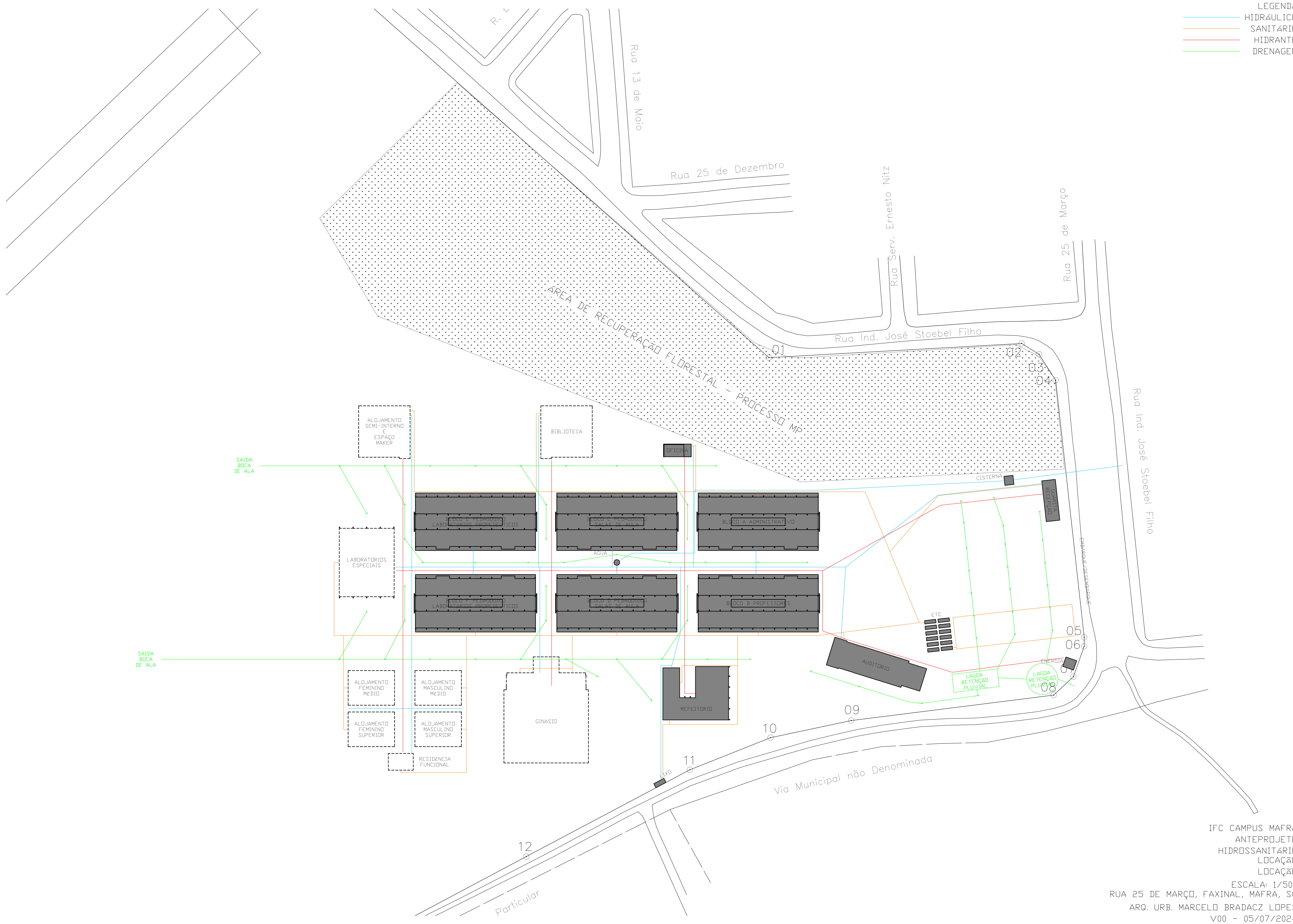

IFC CAMPUS MAFRA  
 ANTEPROJETO  
 HIDROSSANITÁRIO  
 LOCAÇÃO  
 LOCAÇÃO  
 ESCALA: 1/500  
 RUA 25 DE MARÇO, FAXINAL, MAFRA, SC  
 ARQ. URB. MARCELO BRADACZ LOPES  
 V00 - 05/07/2024



- LEGENDA
- ELÉTRICO AÉREO
  - ELÉTRICO ENTERRADO
  - LÓGICA ELETROCALHA
  - LÓGICA ENTERRADA

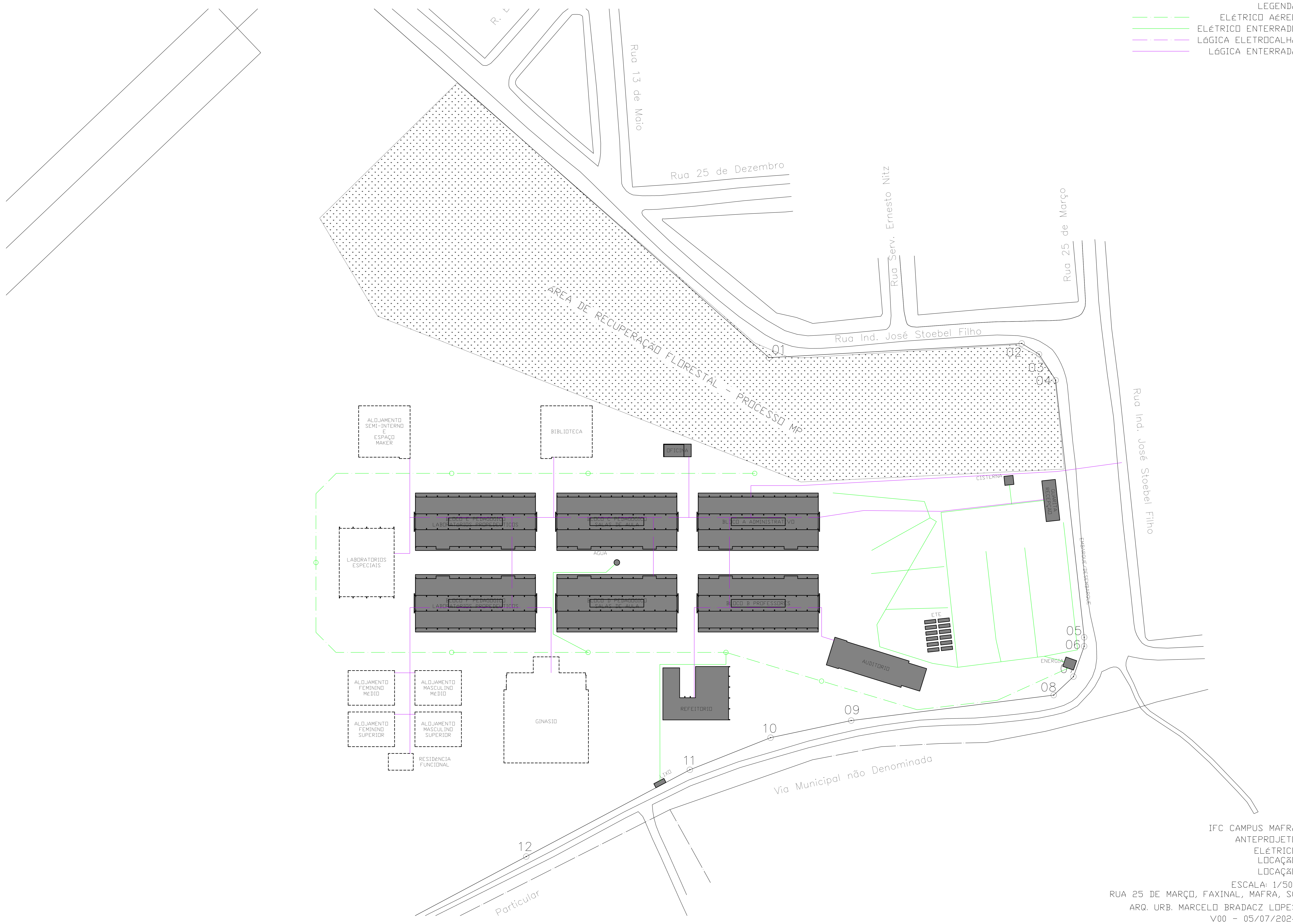

IFC CAMPUS MAFRA  
 ANTEPROJETO  
 ELÉTRICO  
 LOCAÇÃO  
 LOCAÇÃO  
 ESCALA: 1/500  
 RUA 25 DE MARÇO, FAXINAL, MAFRA, SC  
 ARQ. URB. MARCELO BRADACZ LOPES  
 V00 - 05/07/2024

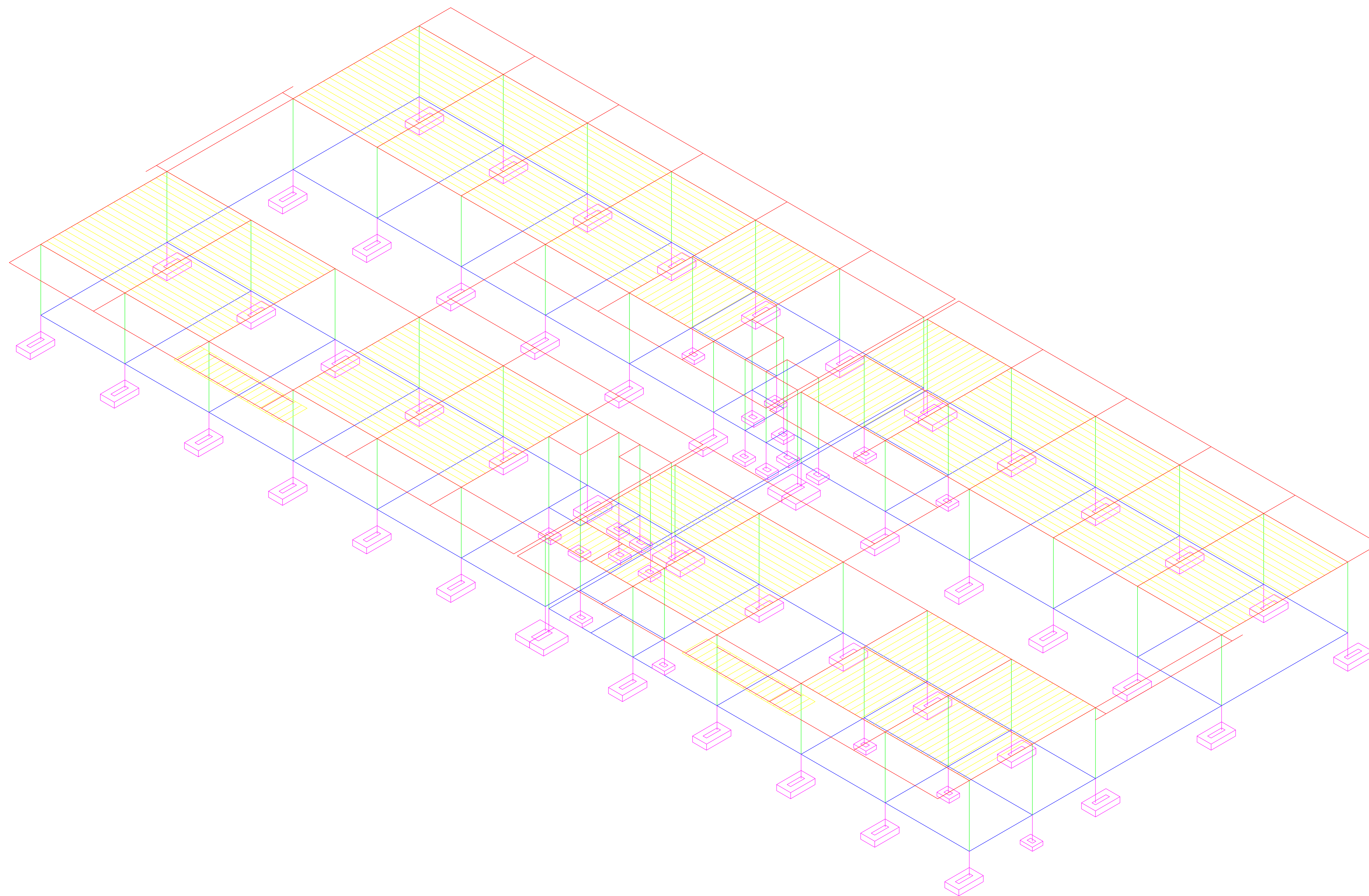

BLOCO A

IFC CAMPUS MAFRA  
ANTEPROJETO  
ESTRUTURA CA  
BLOCO A - ADMINISTRATIVO  
PERSPECTIVA ISOMÉTRICA  
ESCALA: 1/75  
RUA 25 DE MARÇO, FAXINAL, MAFRA, SC  
ARQ. URB. MARCELO BRADACZ LOPES  
V00 - 05/07/2024

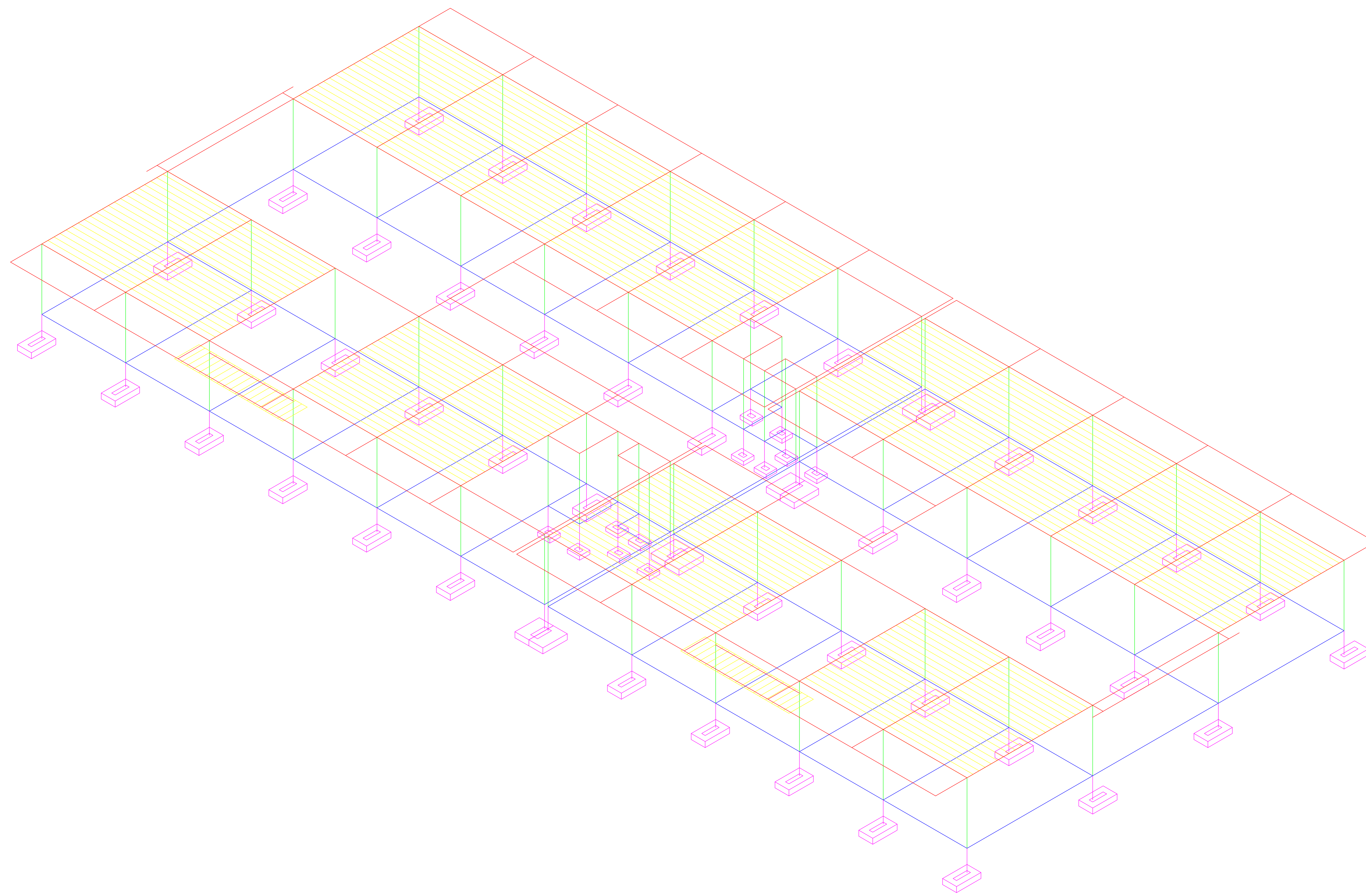

BLOCOS B, C e D

IFC CAMPUS MAFRA  
ANTEPROJETO  
ESTRUTURA CA  
BLOCO B - PROFESSORES  
PERSPECTIVA ISOMÉTRICA  
ESCALA: 1/75  
RUA 25 DE MARÇO, FAXINAL, MAFRA, SC  
ARQ. URB. MARCELO BRADACZ LOPES  
V00 - 05/07/2024

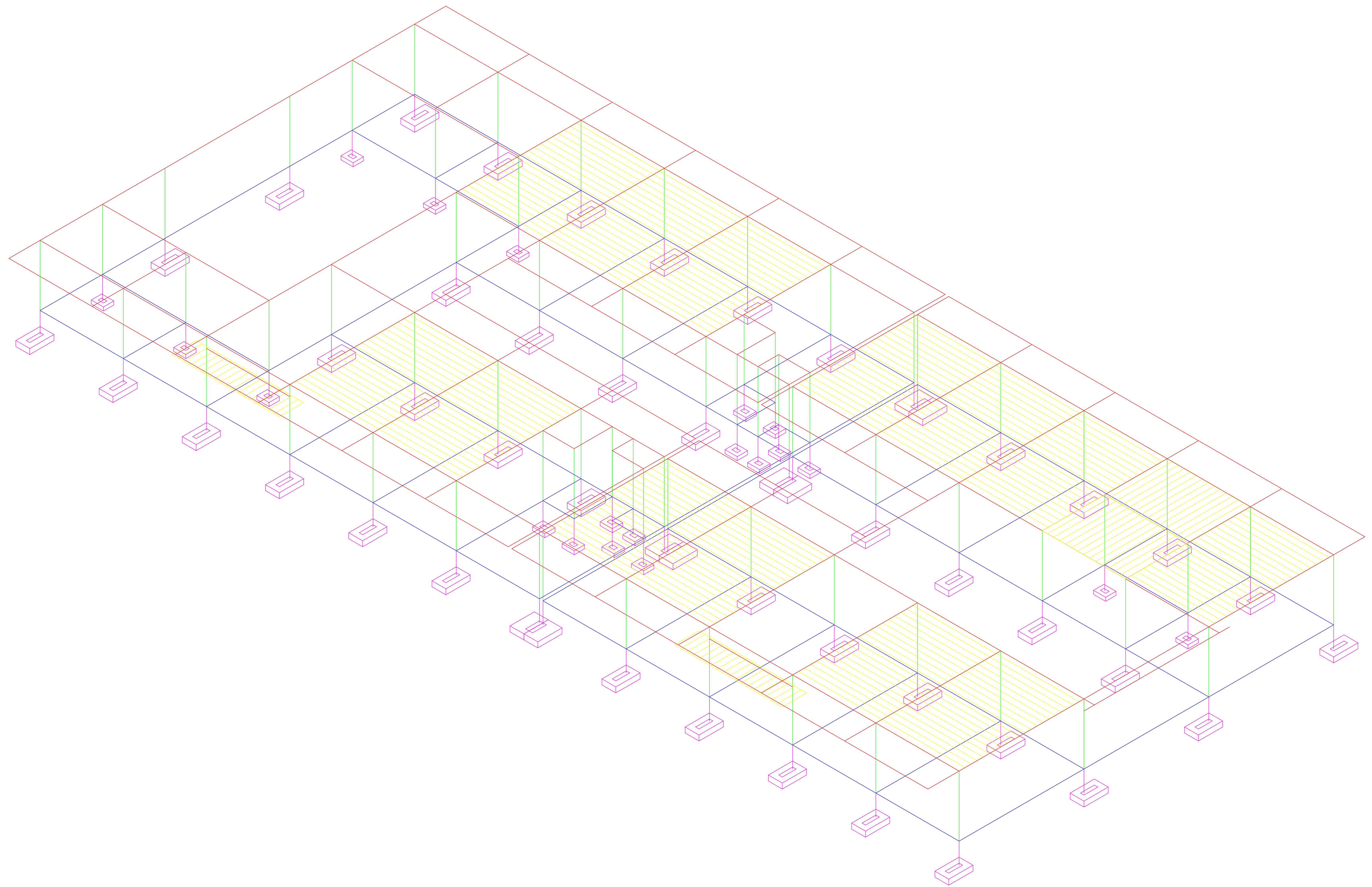

BLOCO E

IFC CAMPUS MAFRA  
ANTEPROJETO  
ESTRUTURA CA  
BLOCO E - LABORATÓRIOS PROPEDEÚTICOS  
PERSPECTIVA ISOMÉTRICA  
ESCALA: 1/75  
RUA 25 DE MARÇO, FAXINAL, MAFRA, SC  
ARQ. URB. MARCELO BRADACZ LOPES  
V00 - 05/07/2024

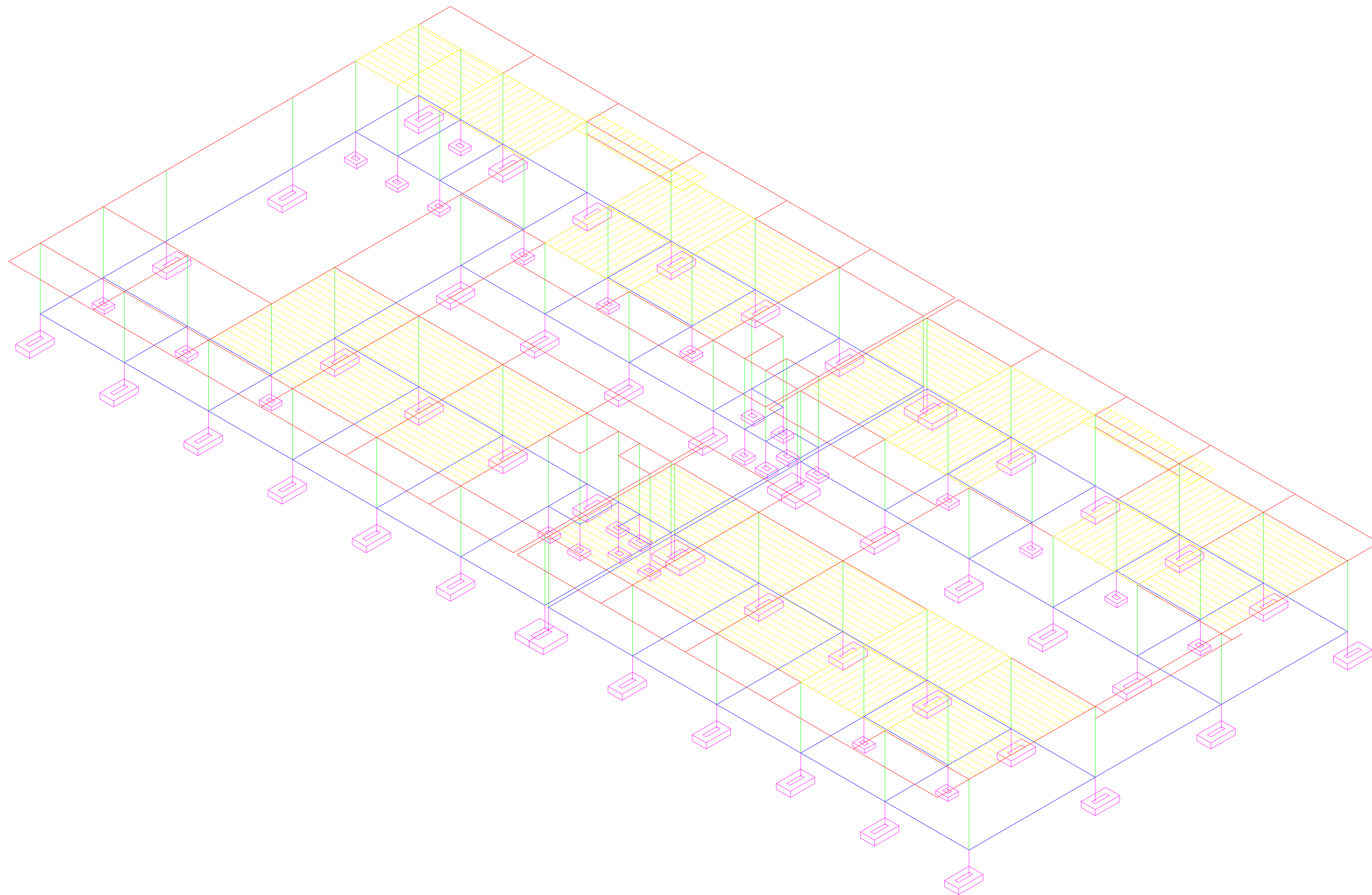

BLOCO F

IFC CAMPUS MAFRA  
ANTEPROJETO  
ESTRUTURA CA  
BLOCO F - LABORATÓRIOS PROPEDEÚTICOS  
PERSPECTIVA ISOMÉTRICA  
ESCALA: 1/75  
RUA 25 DE MARÇO, FAXINAL, MAFRA, SC  
ARQ. URB. MARCELO BRADACZ LOPES  
V00 - 05/07/2024

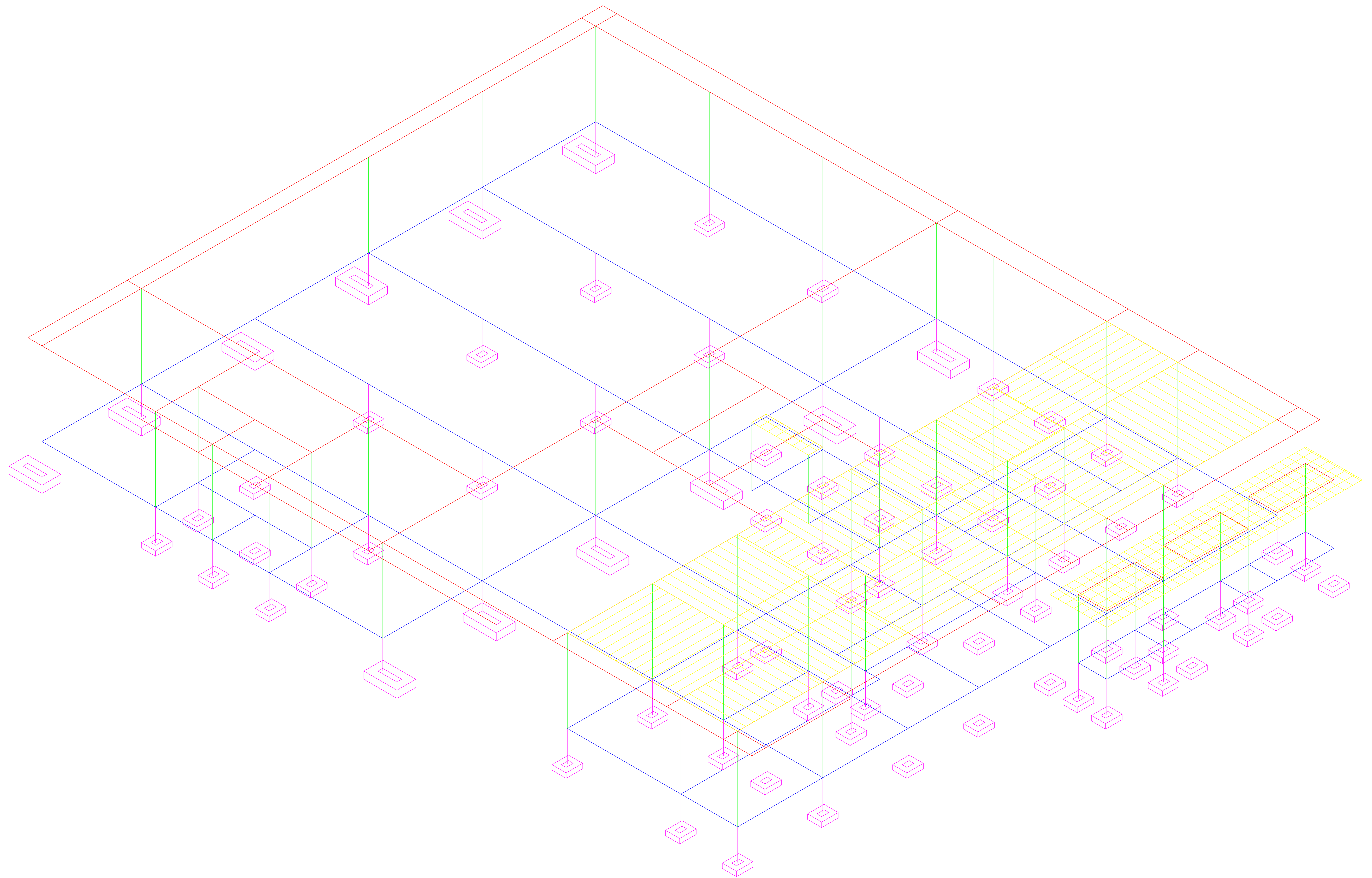

REFEITÓRIO

IFC CAMPUS MAFRA  
ANTEPROJETO  
ESTRUTURA CA  
REFEITÓRIO  
PERSPECTIVA ISOMÉTRICA  
ESCALA: 1/50  
RUA 25 DE MARÇO, FAXINAL, MAFRA, SC  
ARQ. URB. MARCELO BRADACZ LOPES  
V00 - 05/07/2024

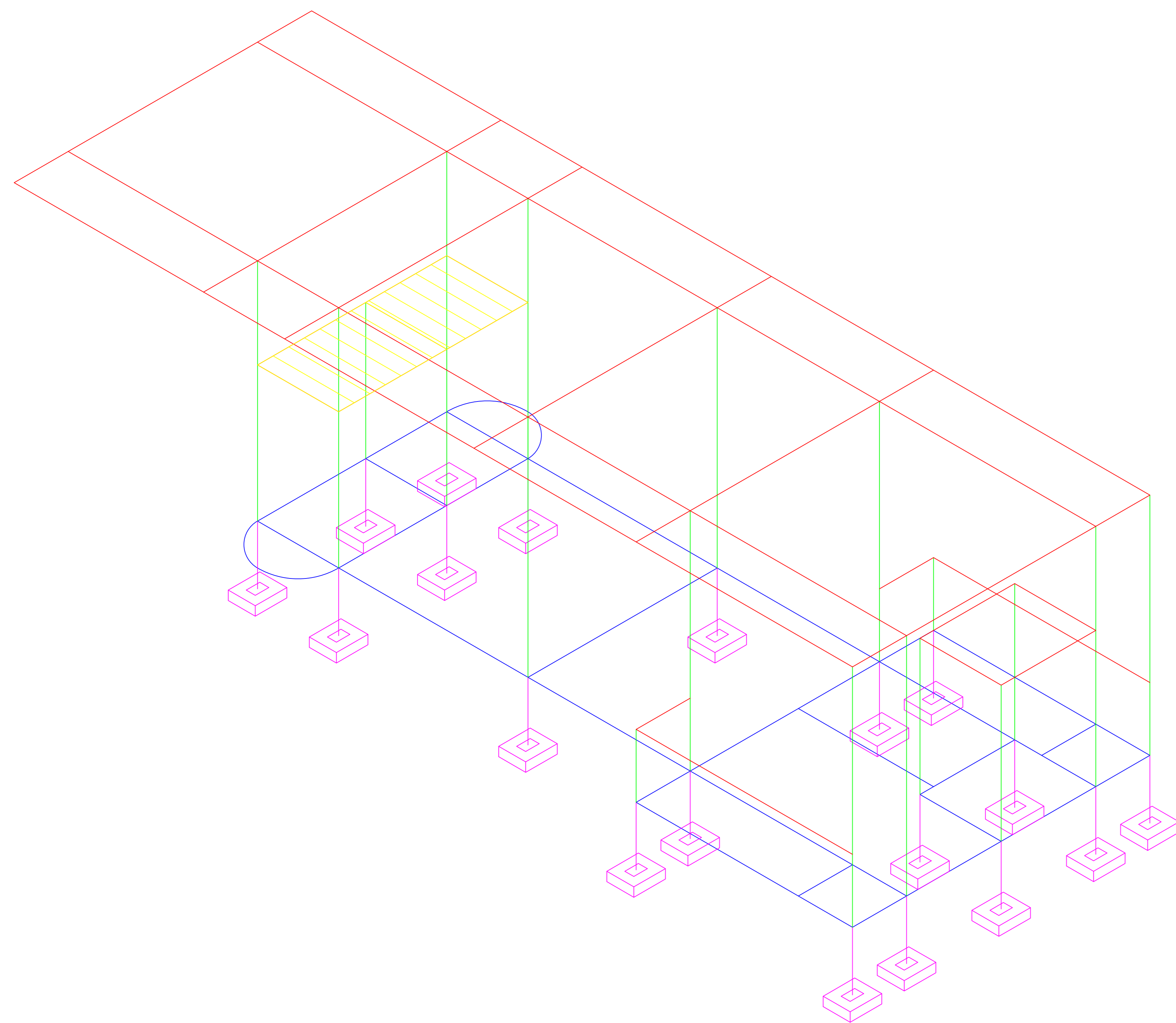

GUARITA/RECEPÇÃO

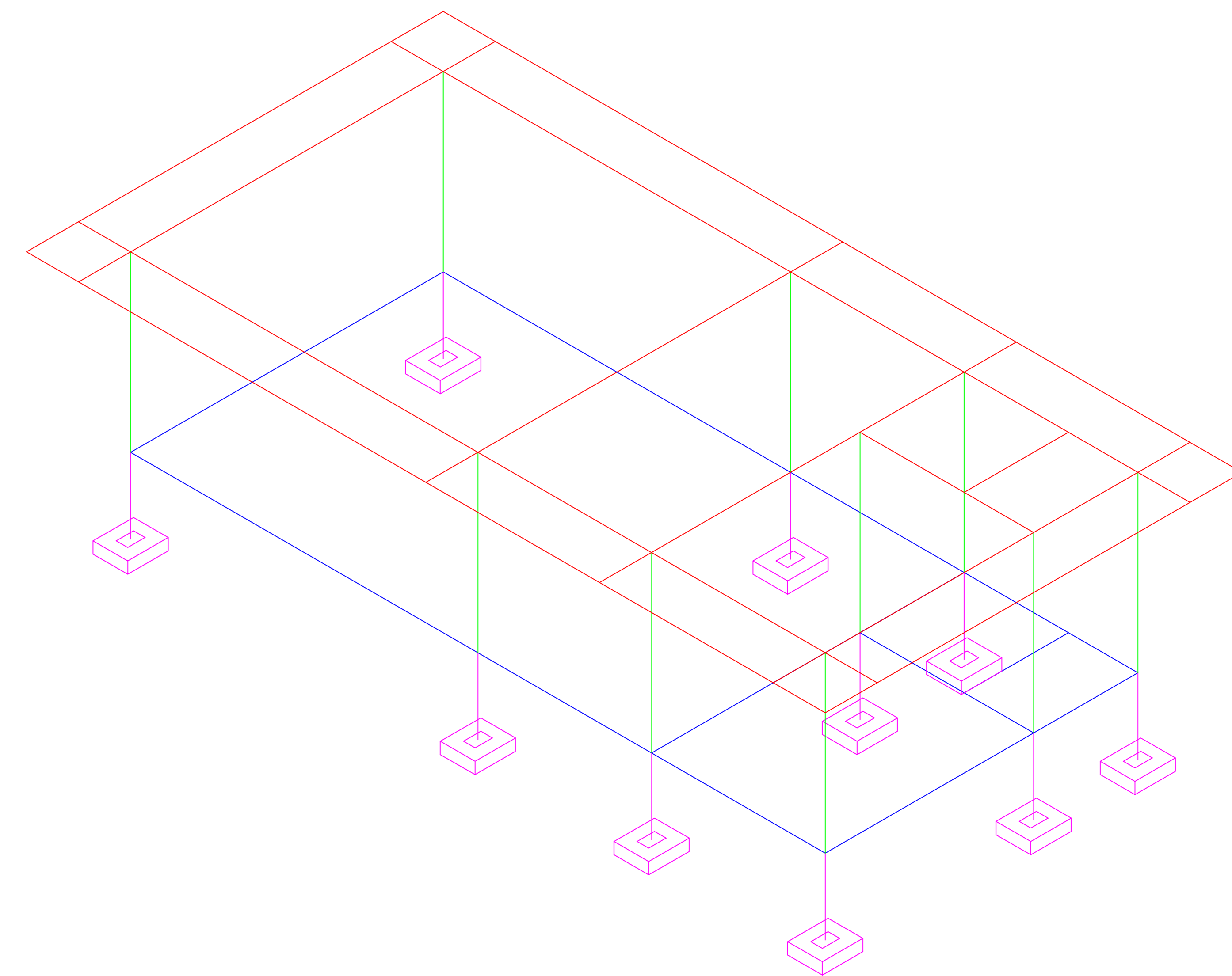

GARAGEM/OFICINA

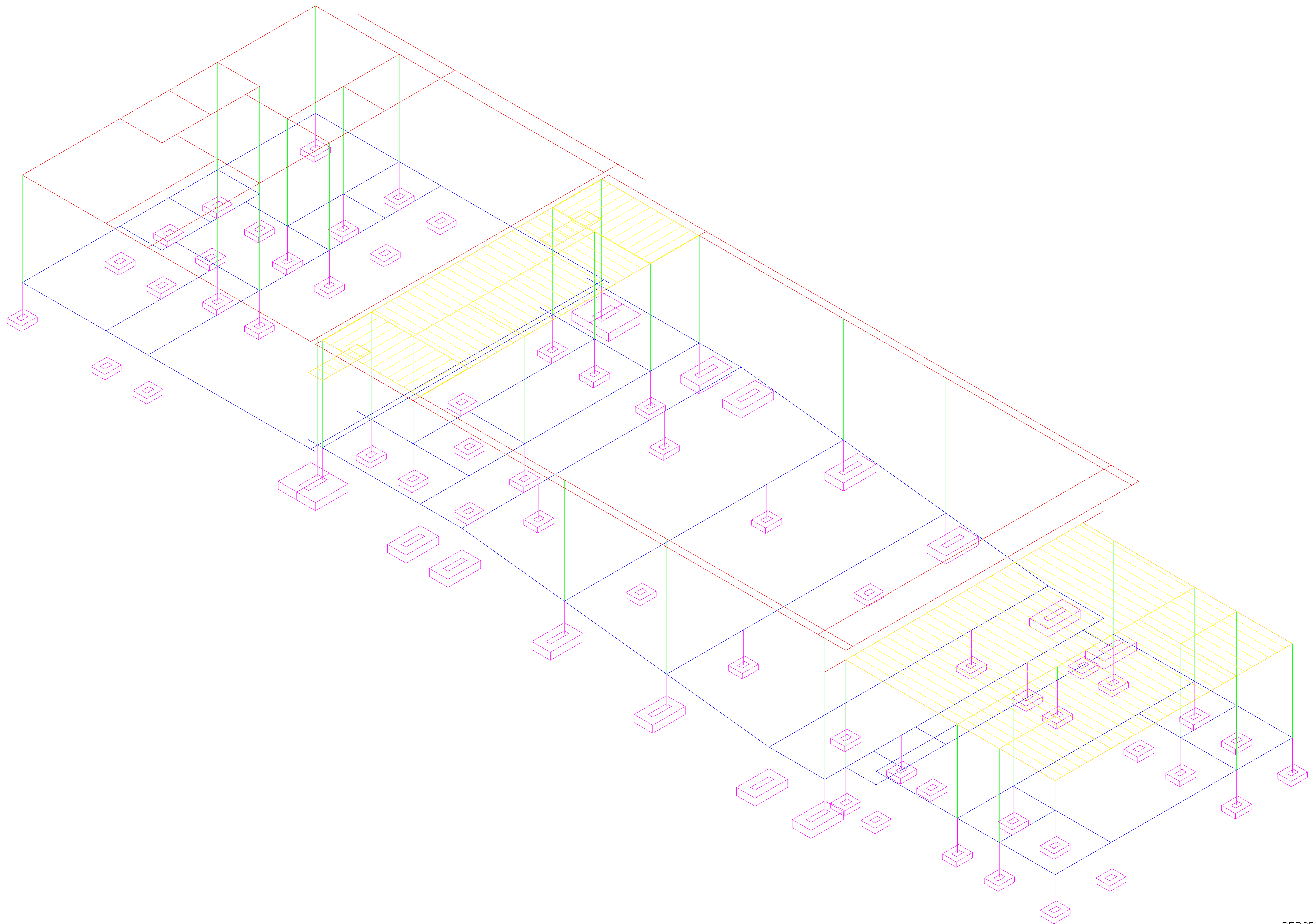

IFC CAMPUS MAFRA  
ANTEPROJETO  
ESTRUTURA CA  
AUDITÓRIO  
PERSPECTIVA ISOMÉTRICA  
ESCALA: 1/50  
RUA 25 DE MARÇO, FAXINAL, MAFRA, SC  
ARQ. URB. MARCELO BRADACZ LOPES  
V00 - 05/07/2024

AUTITÁRIN



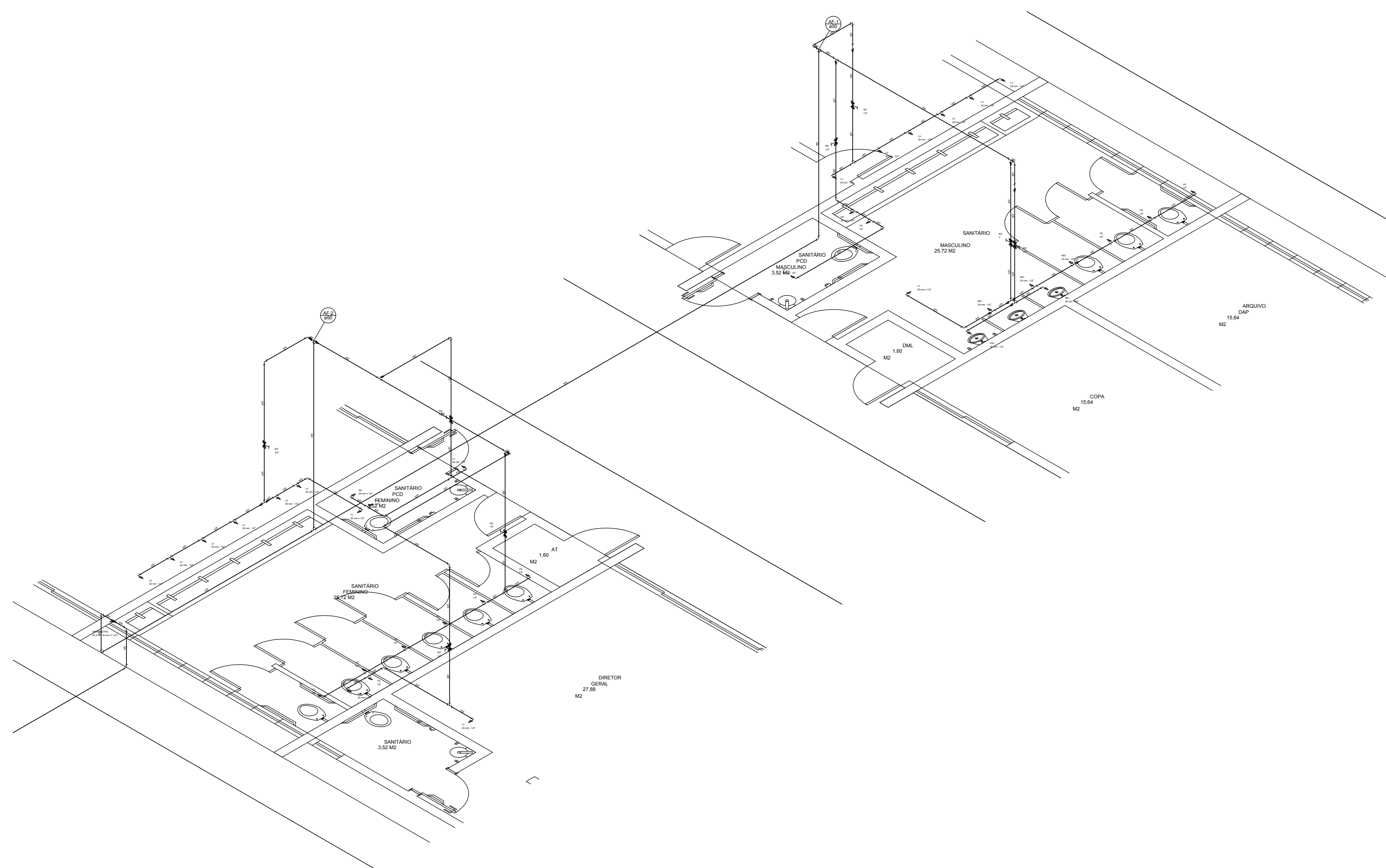

Detalhe H1

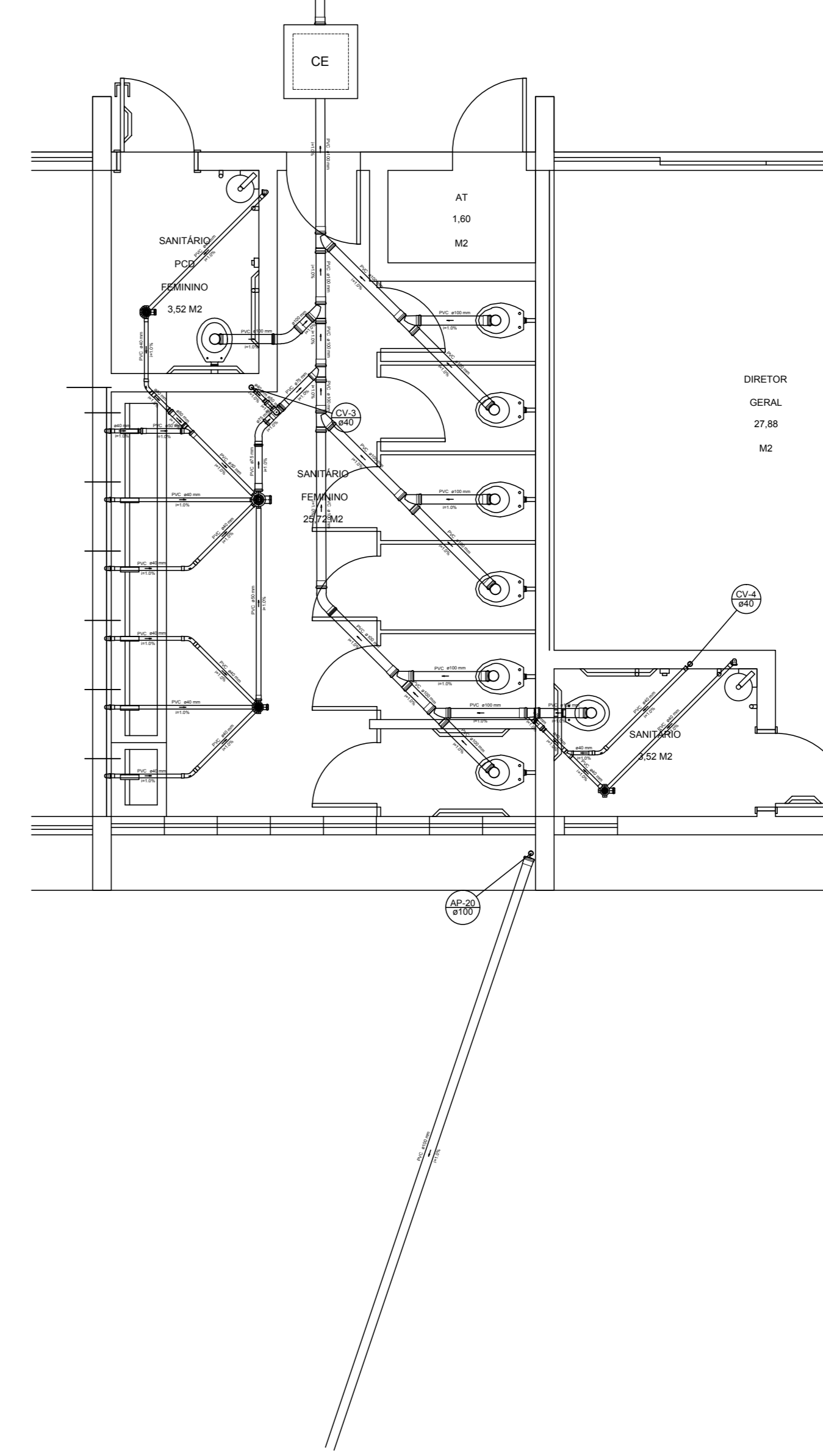
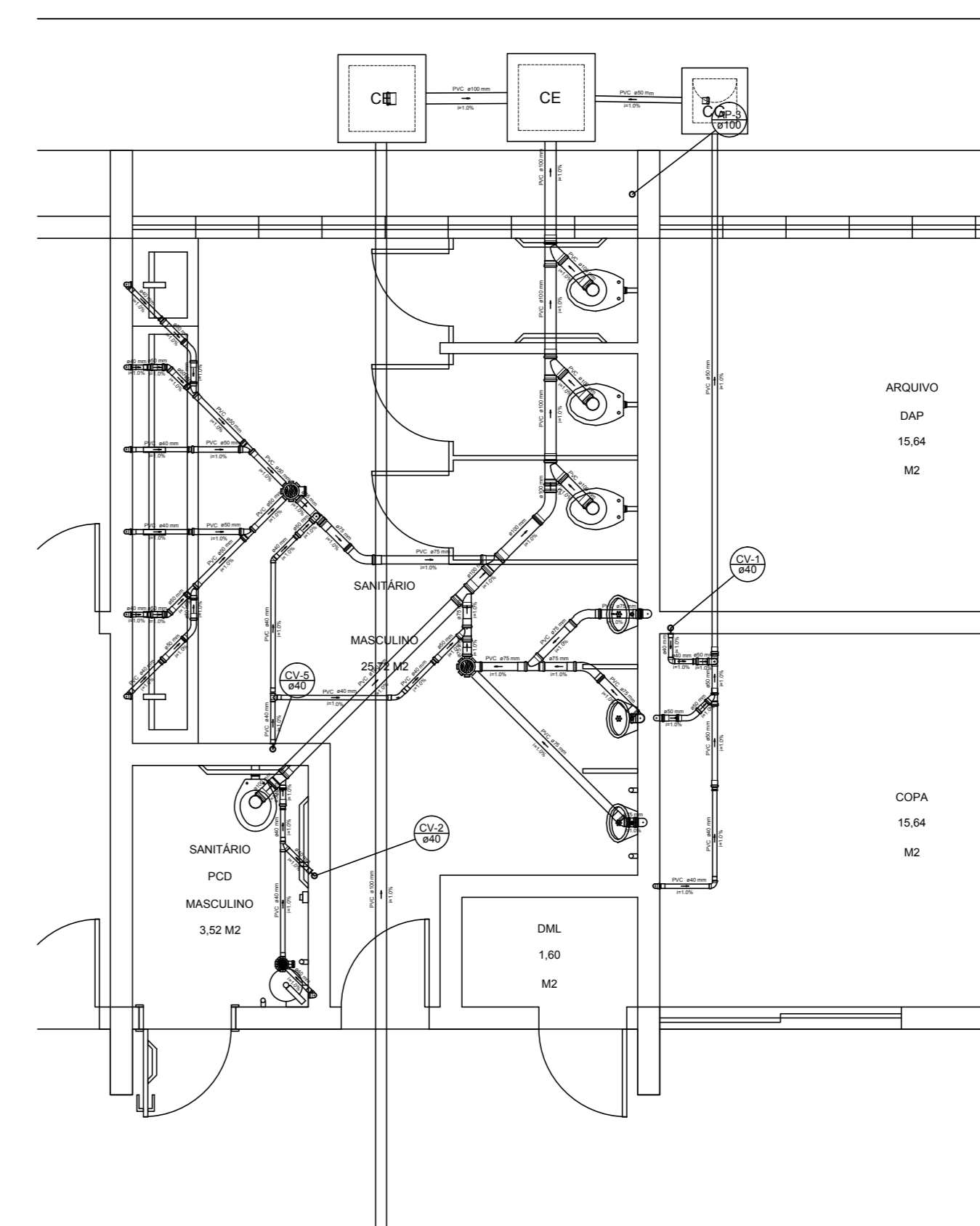

Detalhe S1

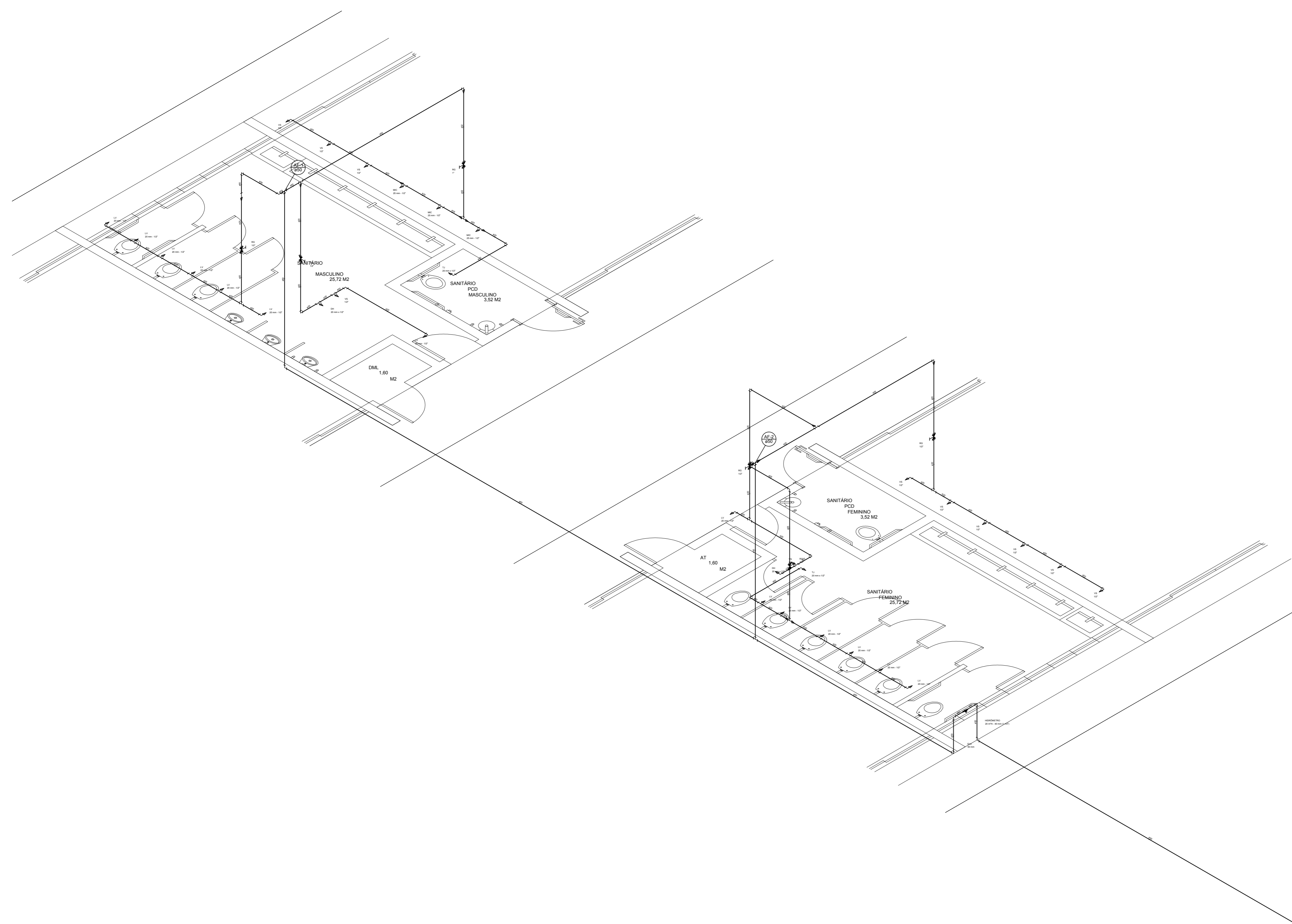

Detalhe H1

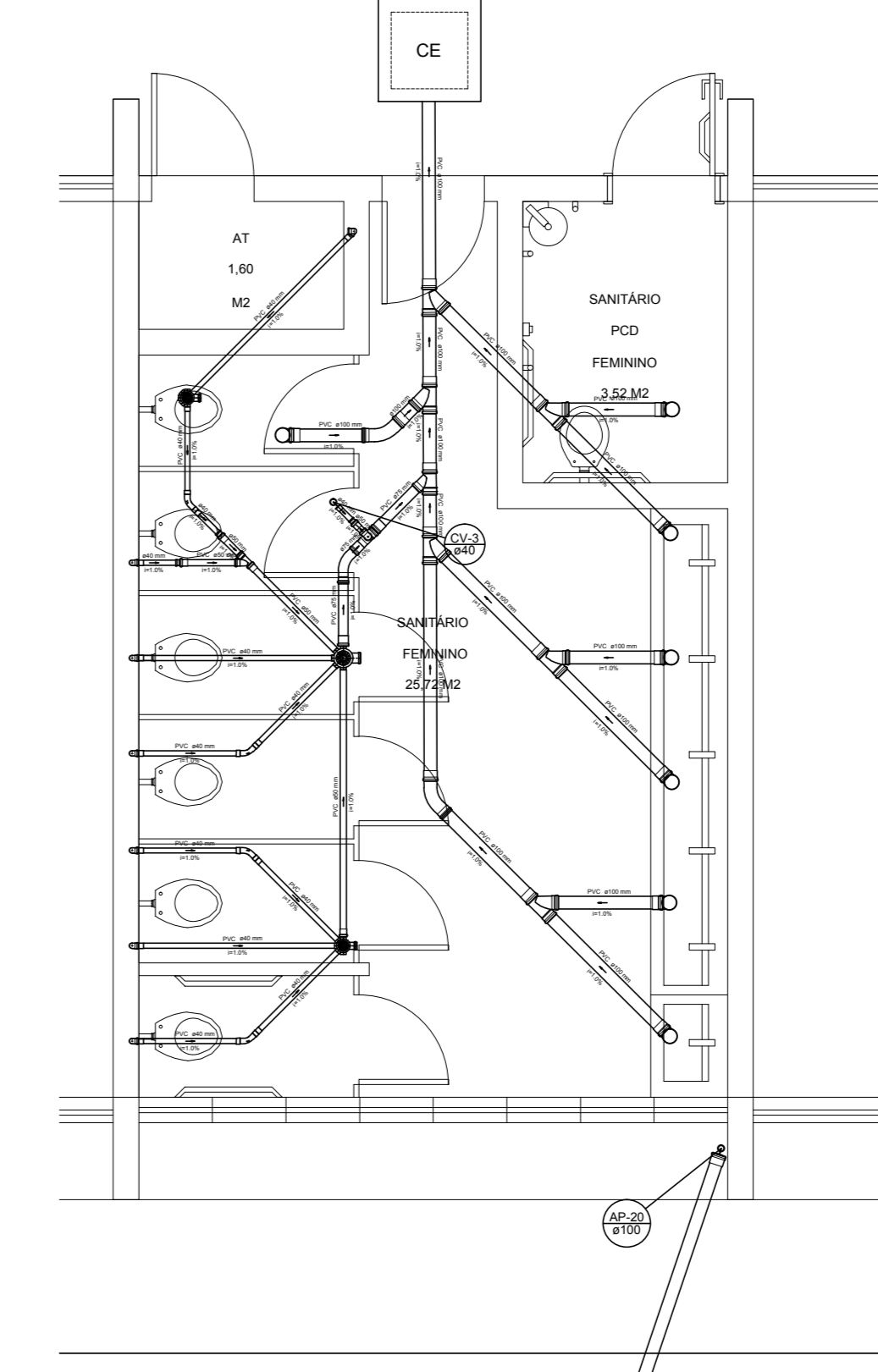
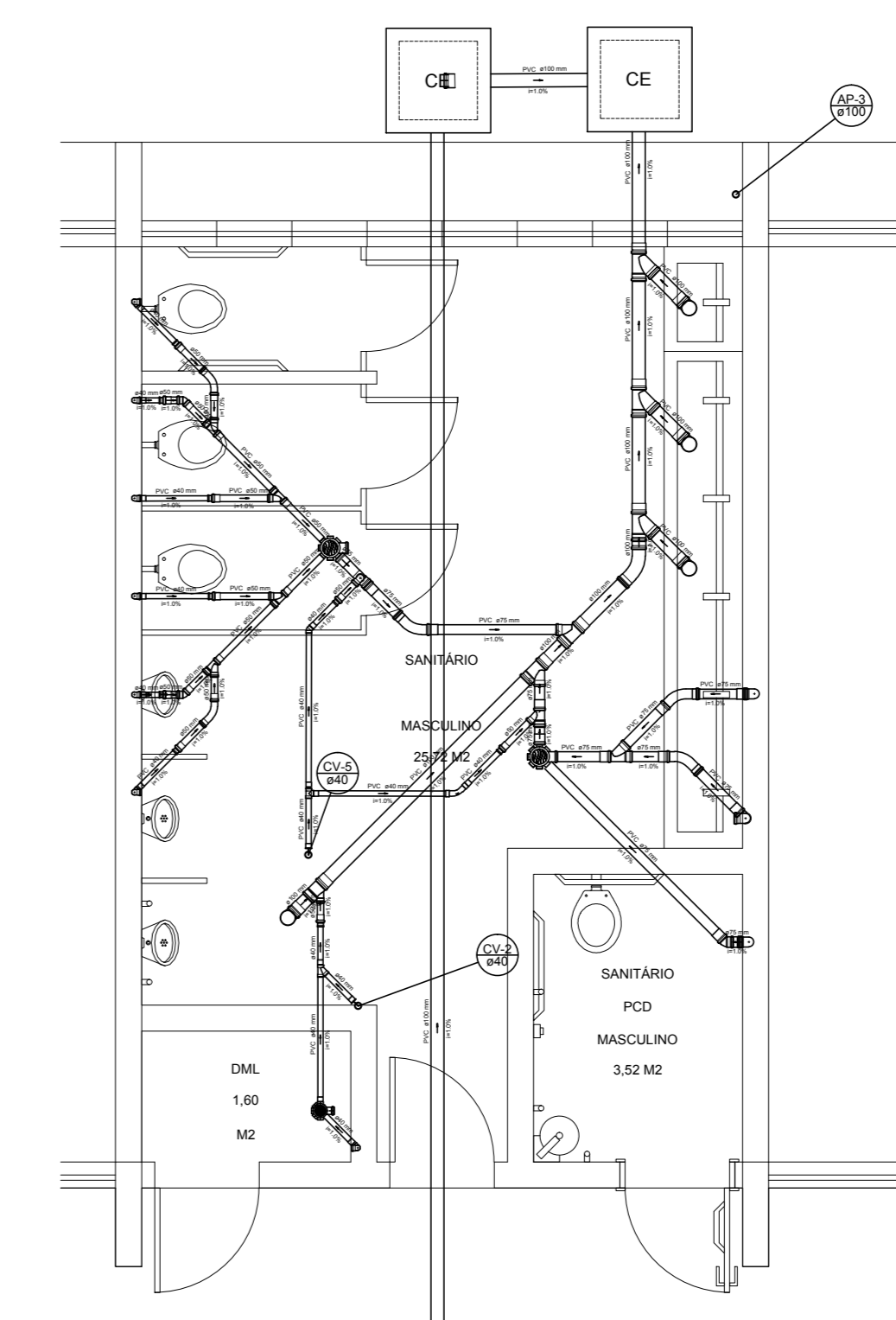

Detalhe S1

IFC CAMPUS MAFRA  
 ANTEPROJETO  
 HIDROSSANITÁRIO  
 BLOCOS B, C e D - PROFESSORES E SALAS DE AULA  
 PERSPECTIVA E PLANTA  
 ESCALA: 1/50  
 RUA 25 DE MARÇO, FAXINAL, MAFRA, SC  
 ARQ. URB. MARCELO BRADACZ LOPES  
 V00 - 05/07/2024

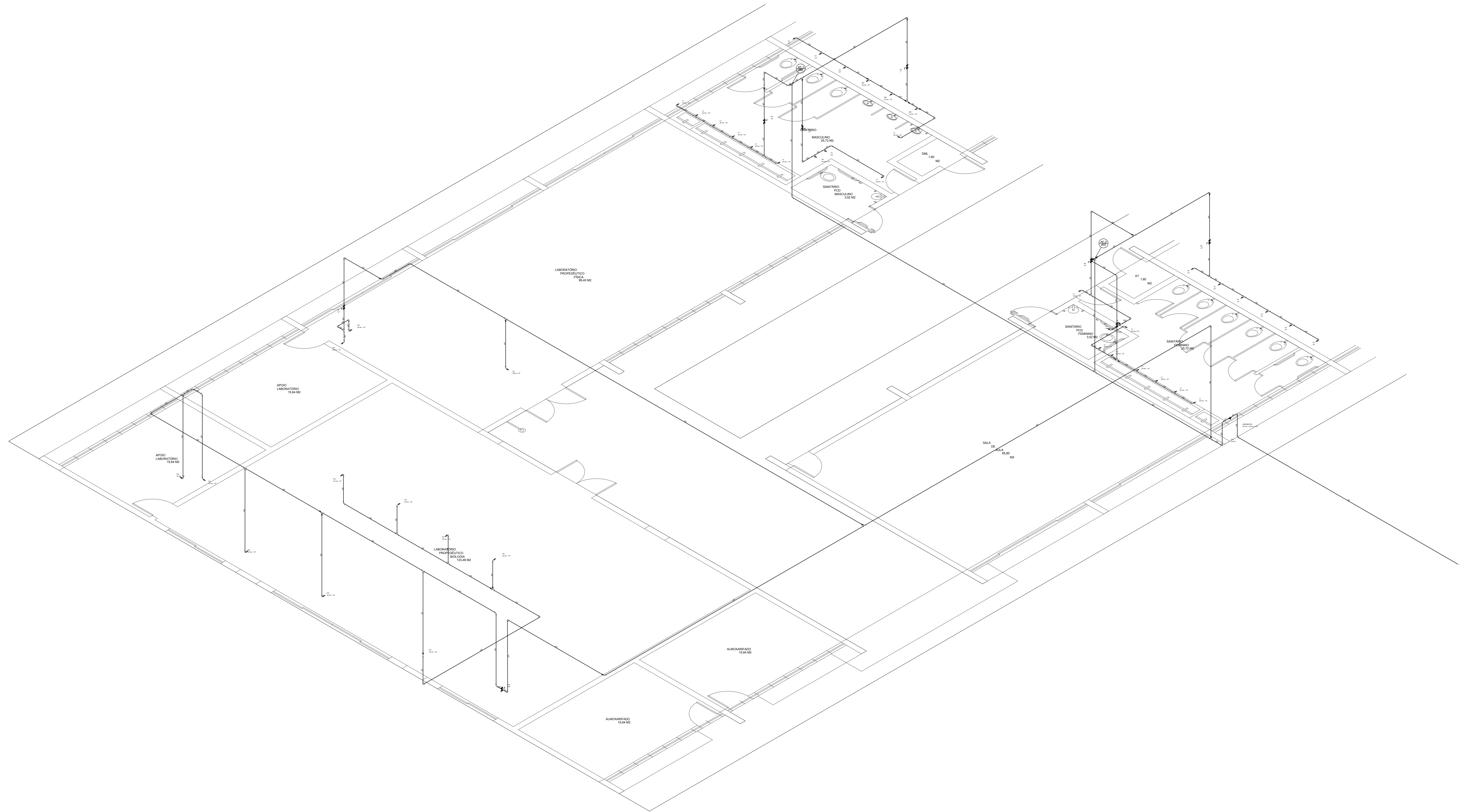

Detalhe H1

IFC CAMPUS MAFRA  
 ANTEPROJETO  
 HIDROSSANITÁRIO  
 BLOCOS E - PEDAGÓGICO LABORATÓRIOS PROPEDEUTICOS  
 PERSPECTIVA HIDRÁULICA  
 ESCALA: 1/50  
 RUA 25 DE MARÇO, FAXINAL, MAFRA, SC  
 ARQ. URB. MARCELO BRADACZ LOPES  
 V00 - 05/07/2024

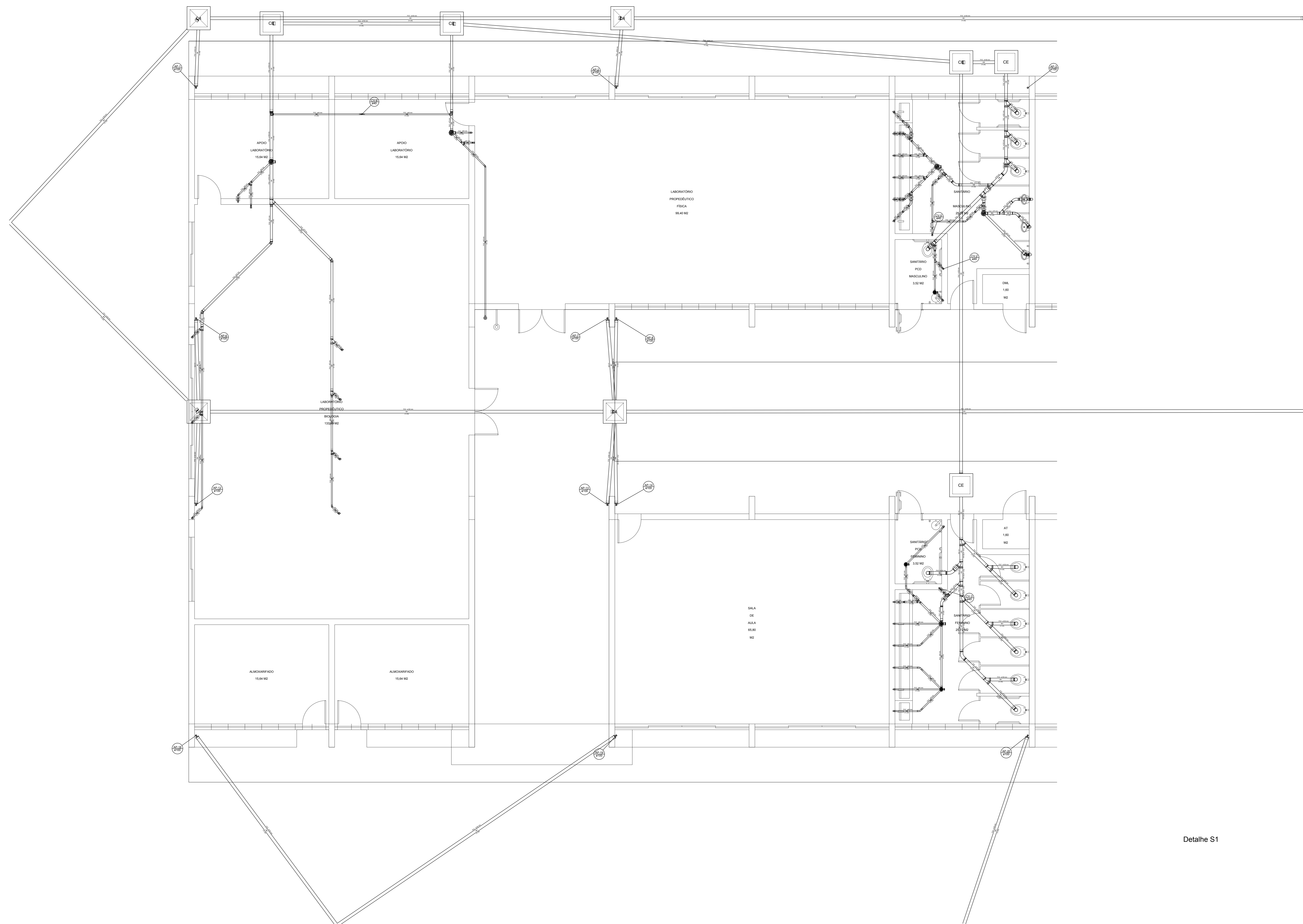

Detalhe S1



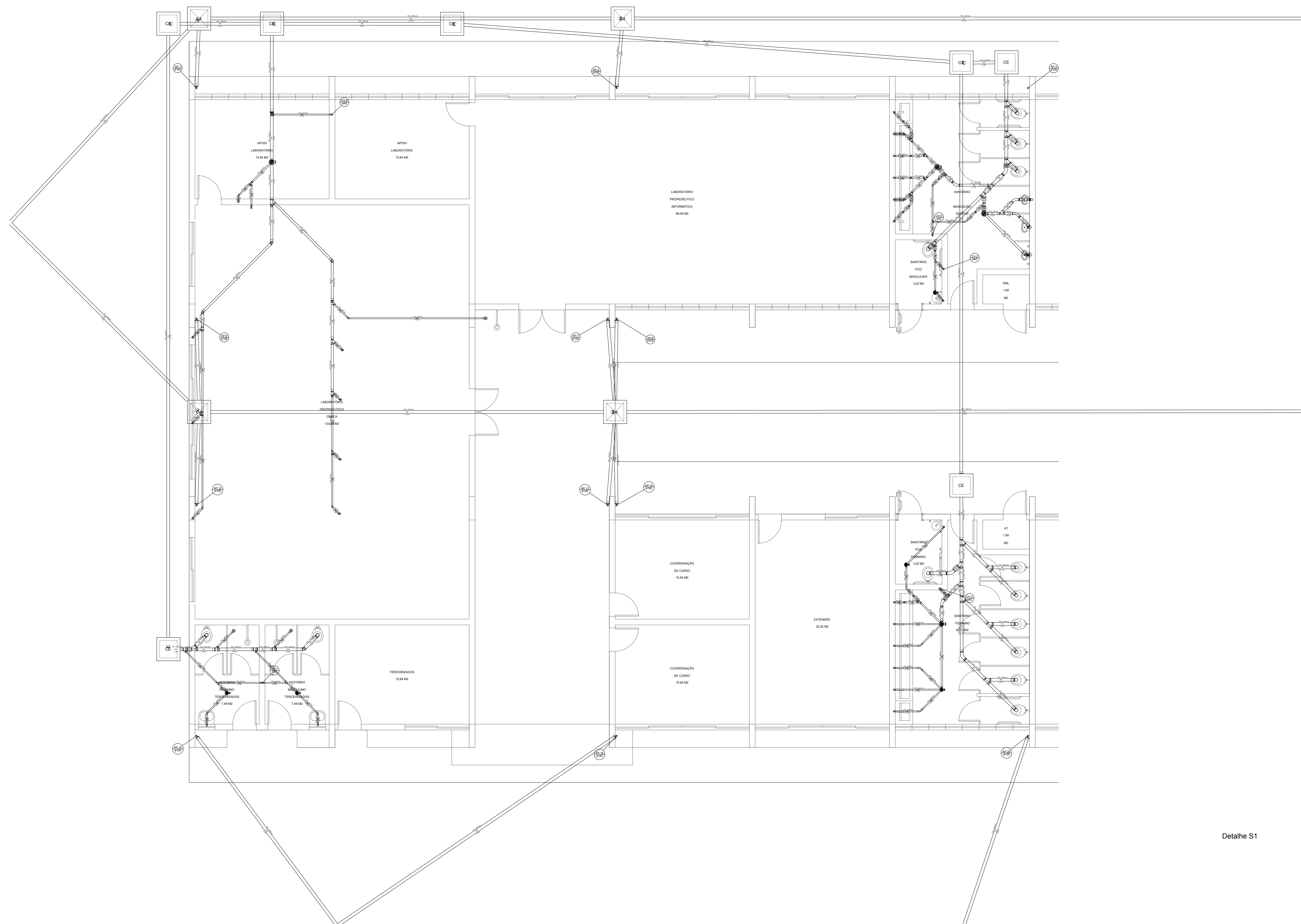

Detalhe S1

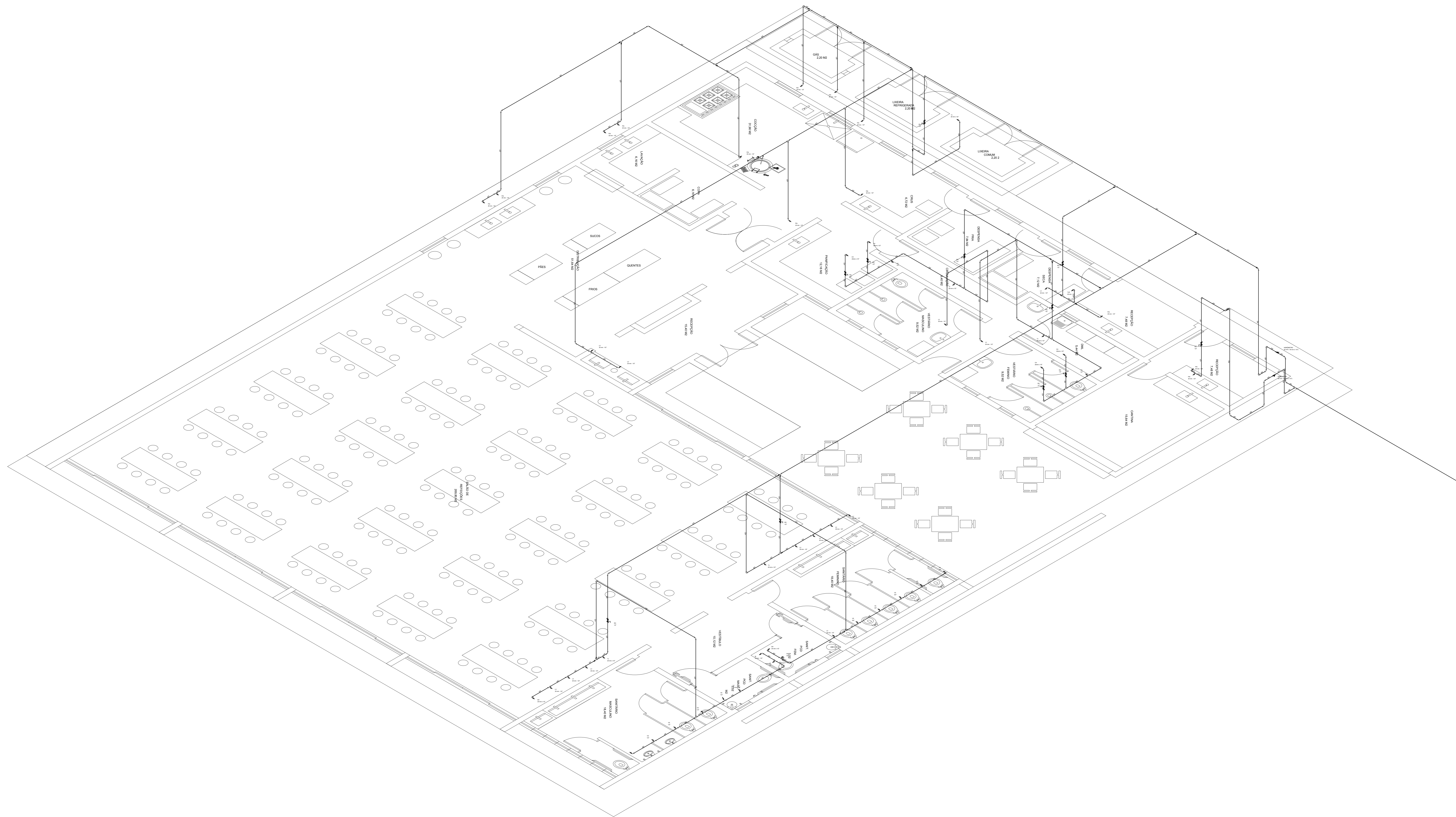

Detalhe H1

IFC CAMPUS MAFRA  
 ANTEPROJETO  
 HIDROSSANITÁRIO  
 REFEITÓRIO  
 PERSPECTIVA HIDRÁULICA  
 ESCALA: 1/50  
 RUA 25 DE MARÇO, FAXINAL, MAFRA, SC  
 ARQ. URB. MARCELO BRADACZ LOPES  
 V00 - 05/07/2024

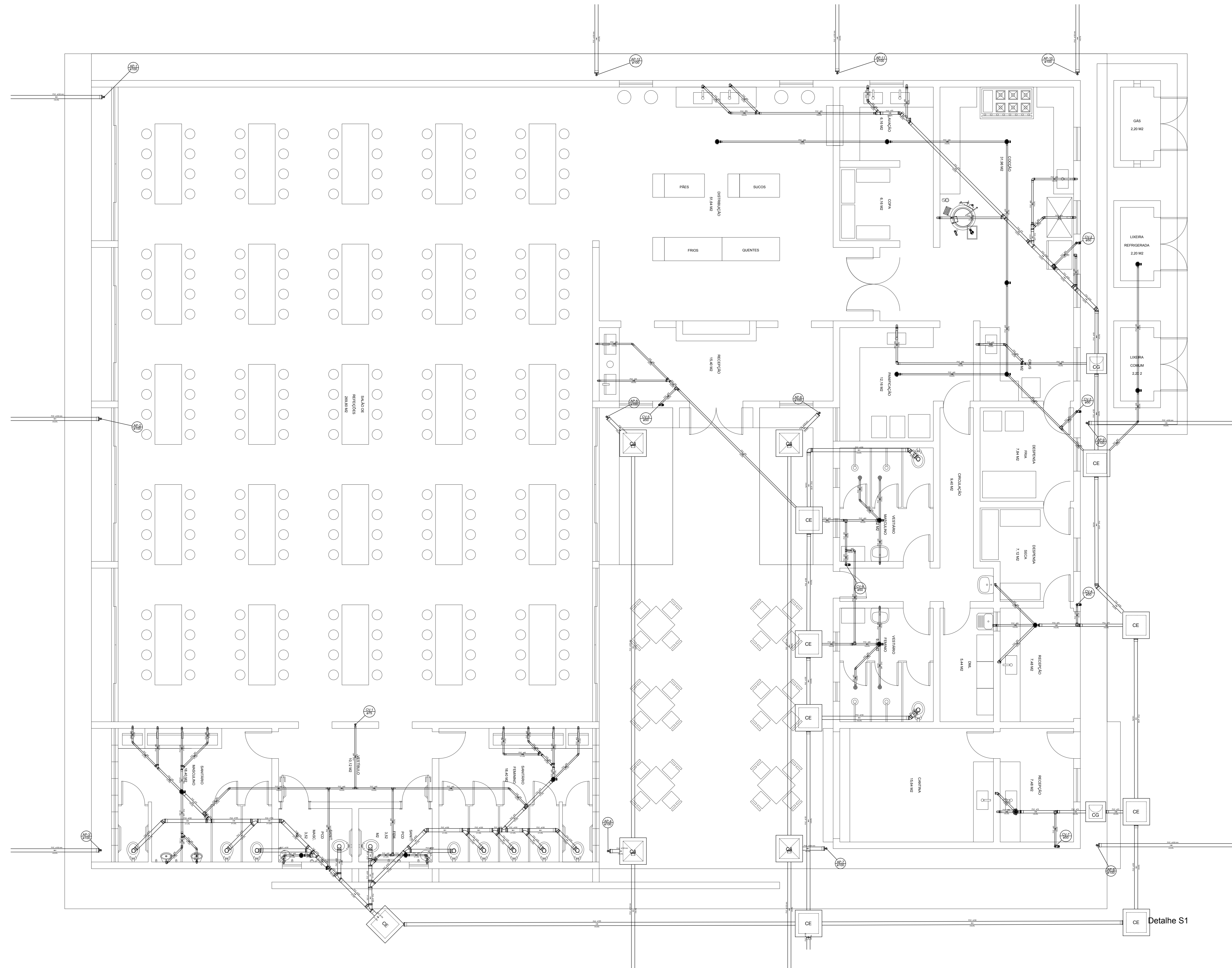

IFC CAMPUS MAFRA  
 ANTEPROJETO  
 HIDROSSANITÁRIO  
 REFEITÓRIO  
 PLANTA SANITÁRIA  
 ESCALA: 1/50  
 RUA 25 DE MARÇO, FAXINAL, MAFRA, SC  
 ARQ. URB. MARCELO BRADACZ LOPES  
 V00 - 05/07/2024



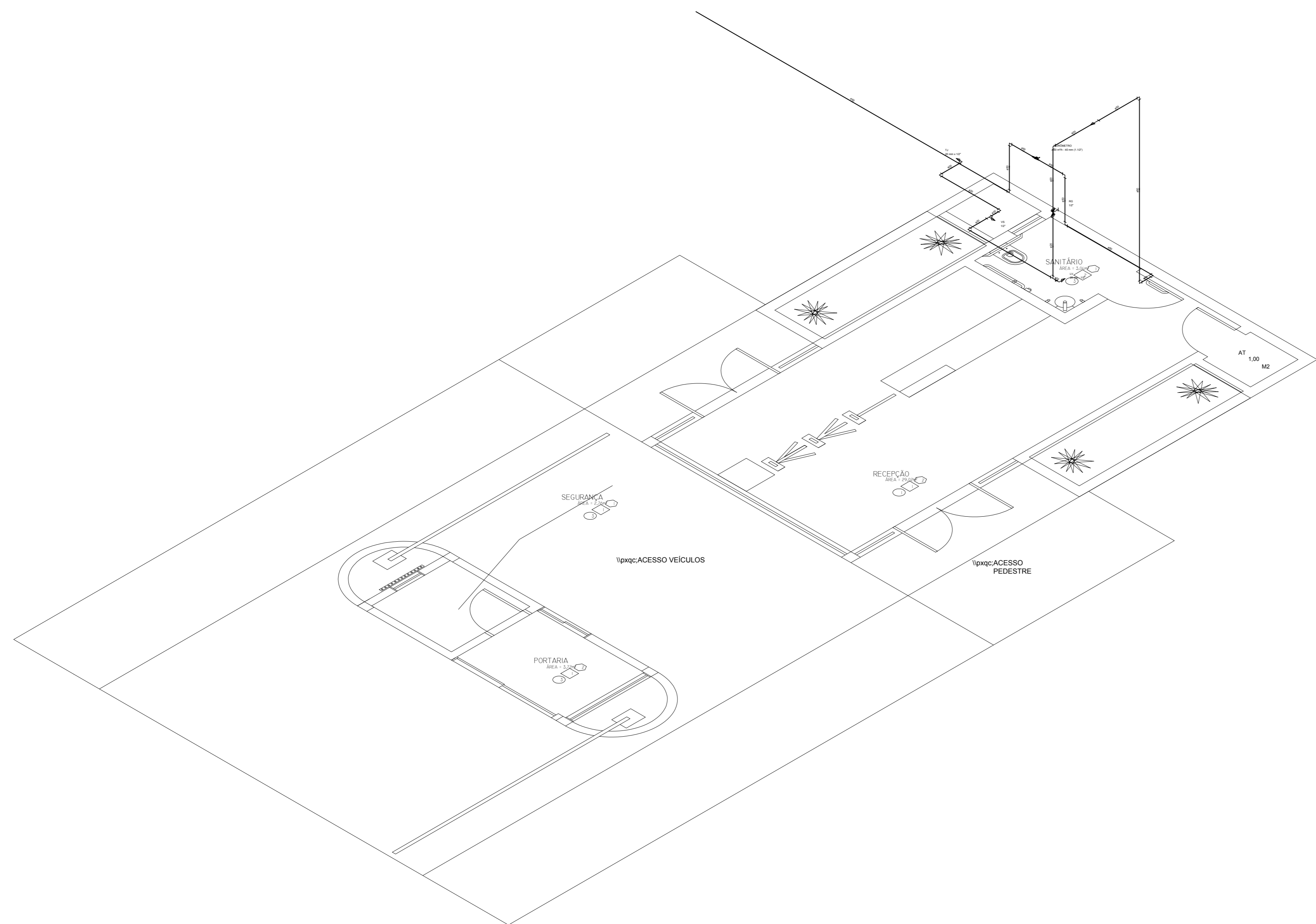

Detalhe H1

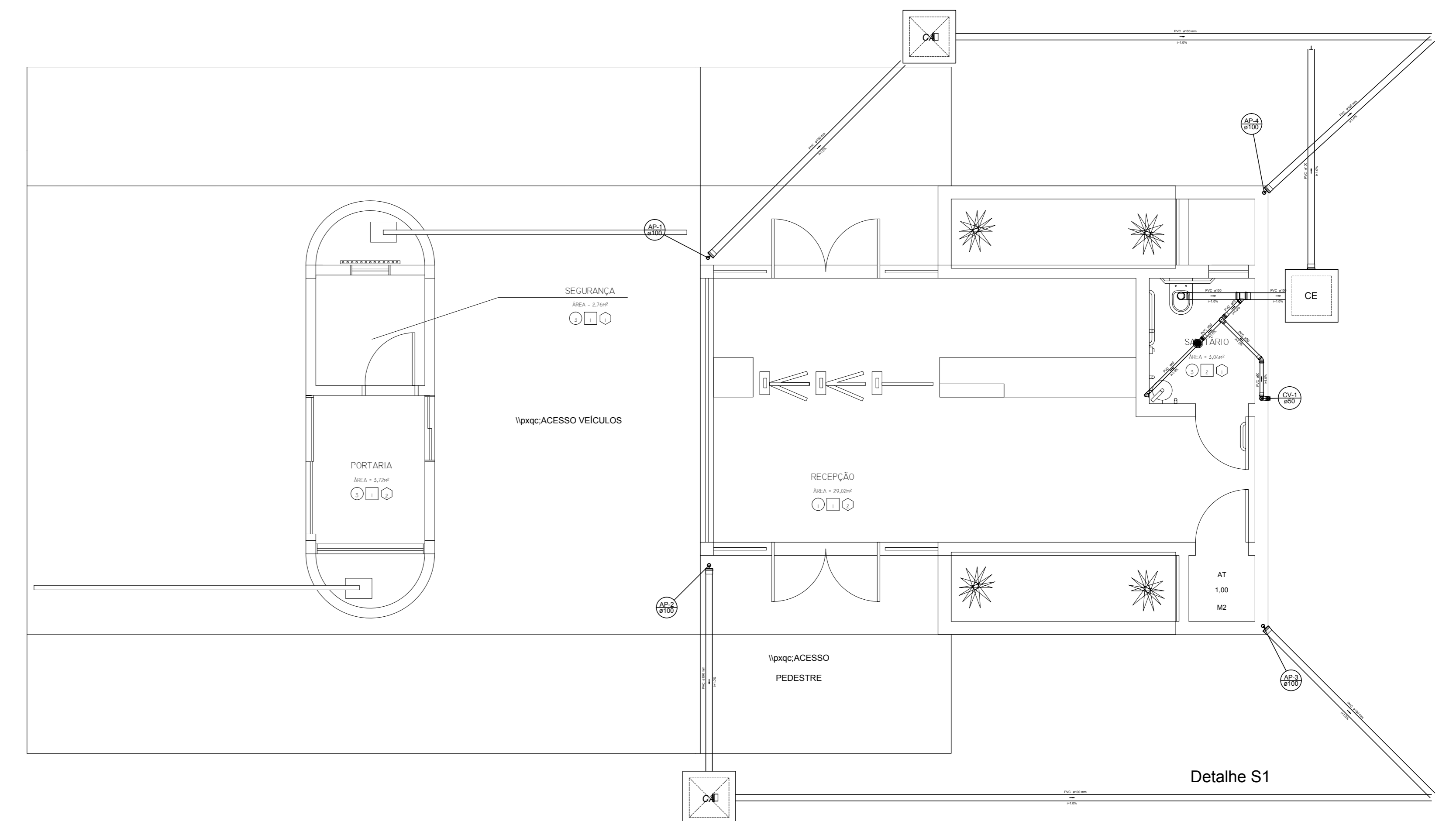

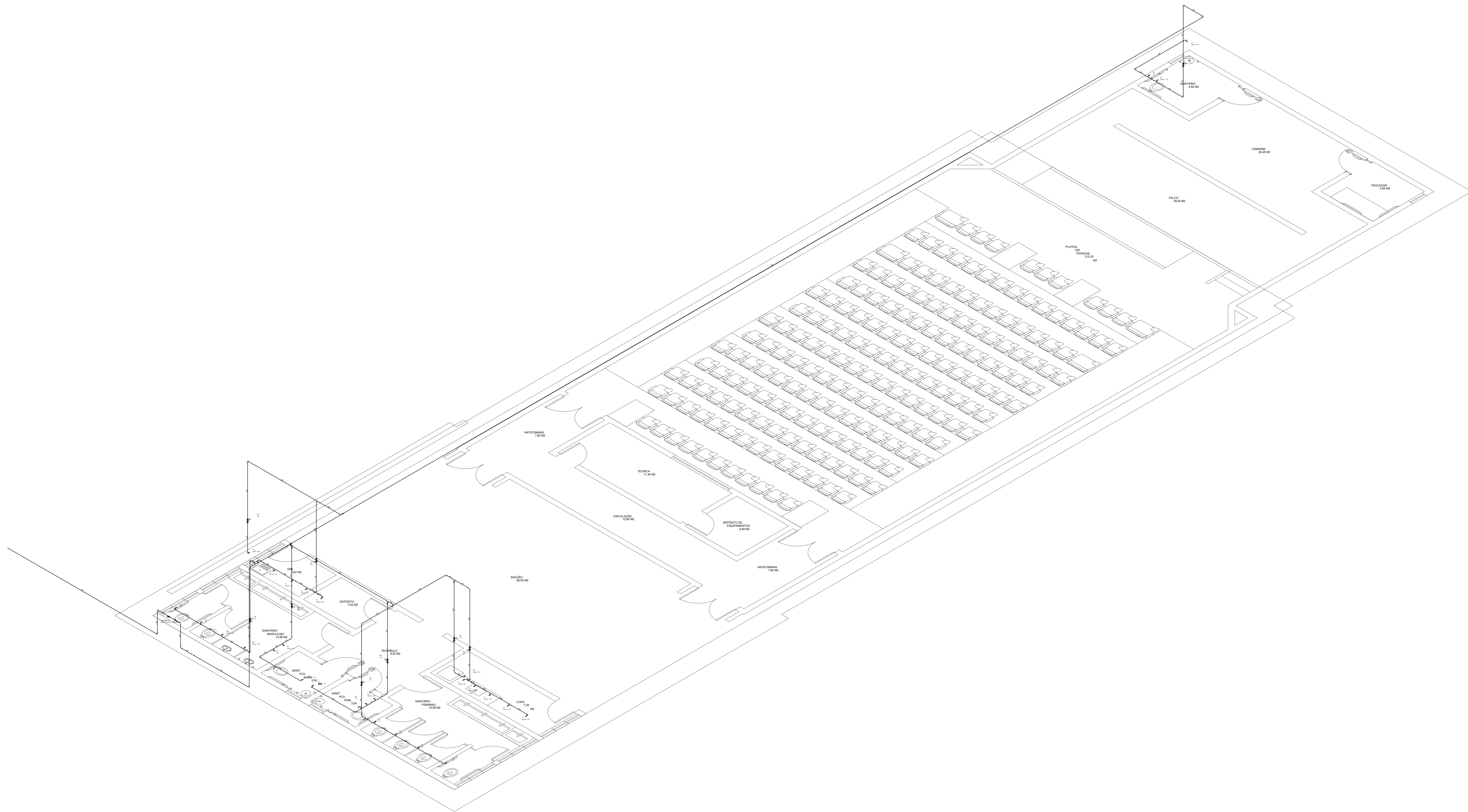

Detalhe H1

IFC CAMPUS MAFRA  
 ANTEPROJETO  
 HIDROSSANITÁRIO  
 AUDITÓRIO  
 PERSPECTIVA HIDRÁULICA  
 ESCALA: 1/50  
 RUA 25 DE MARÇO, FAXINAL, MAFRA, SC  
 ARQ. URB. MARCELO BRADACZ LOPES  
 V00 - 05/07/2024

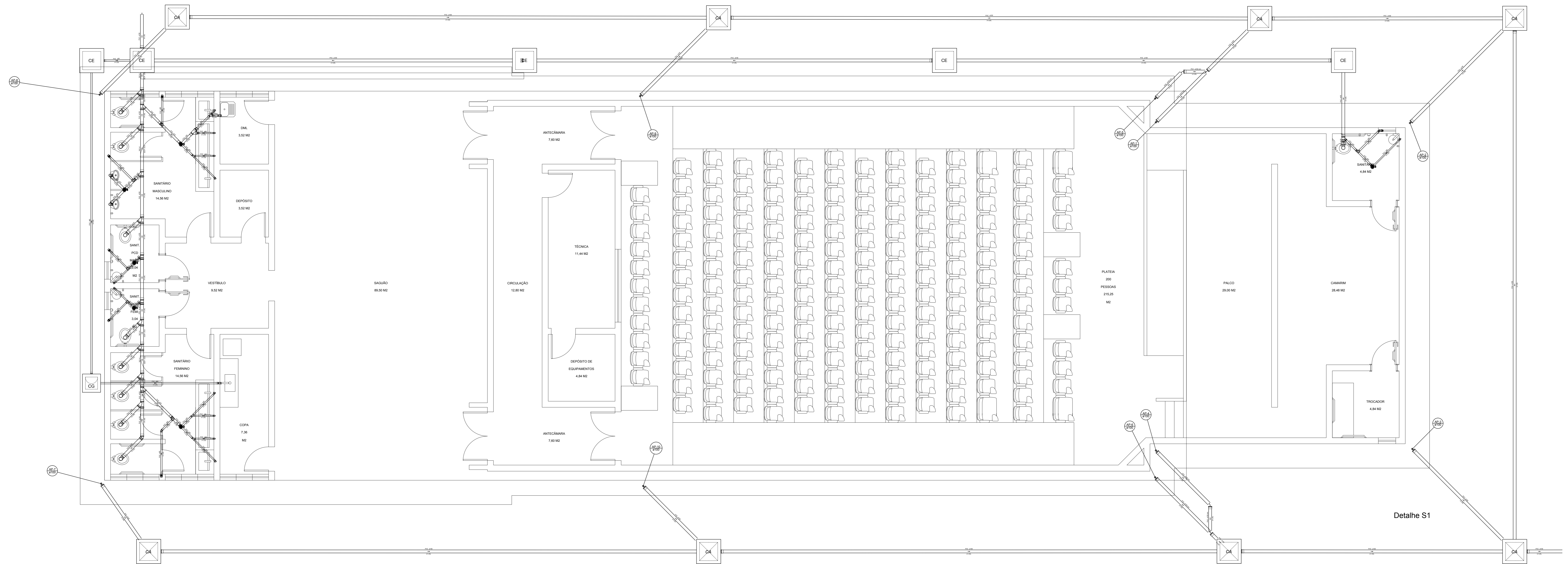

Detalhe S1

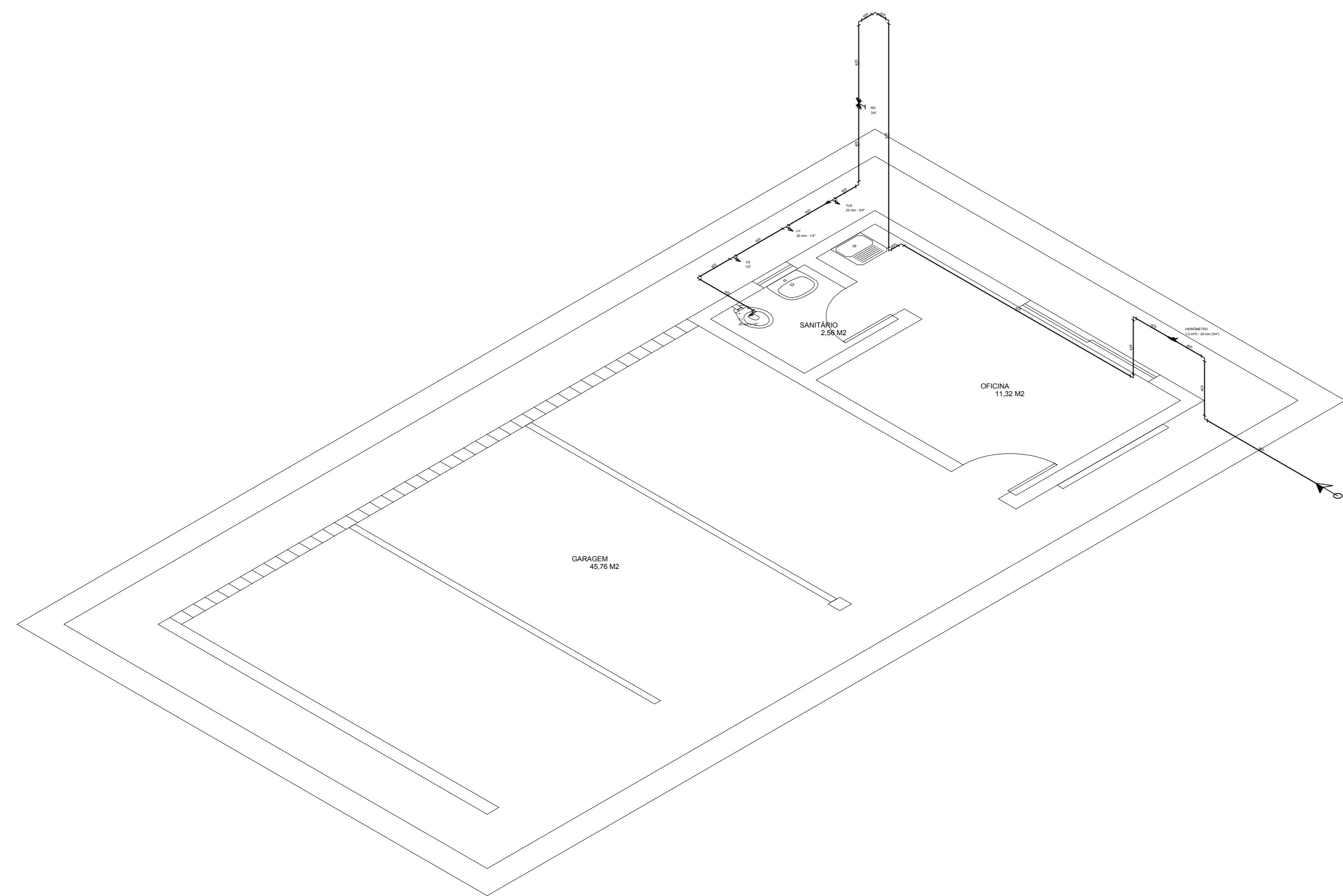

Detalhe H1

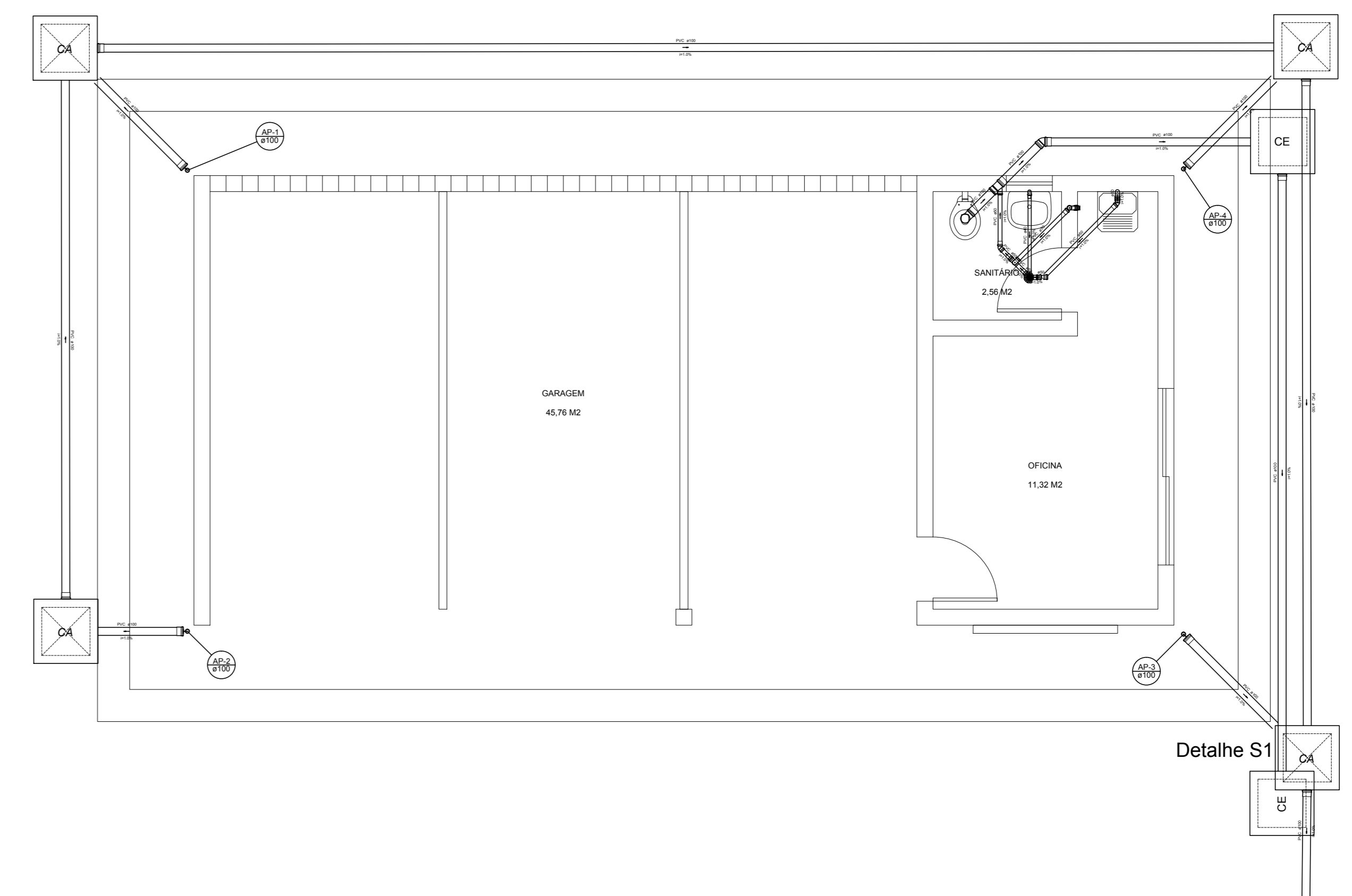

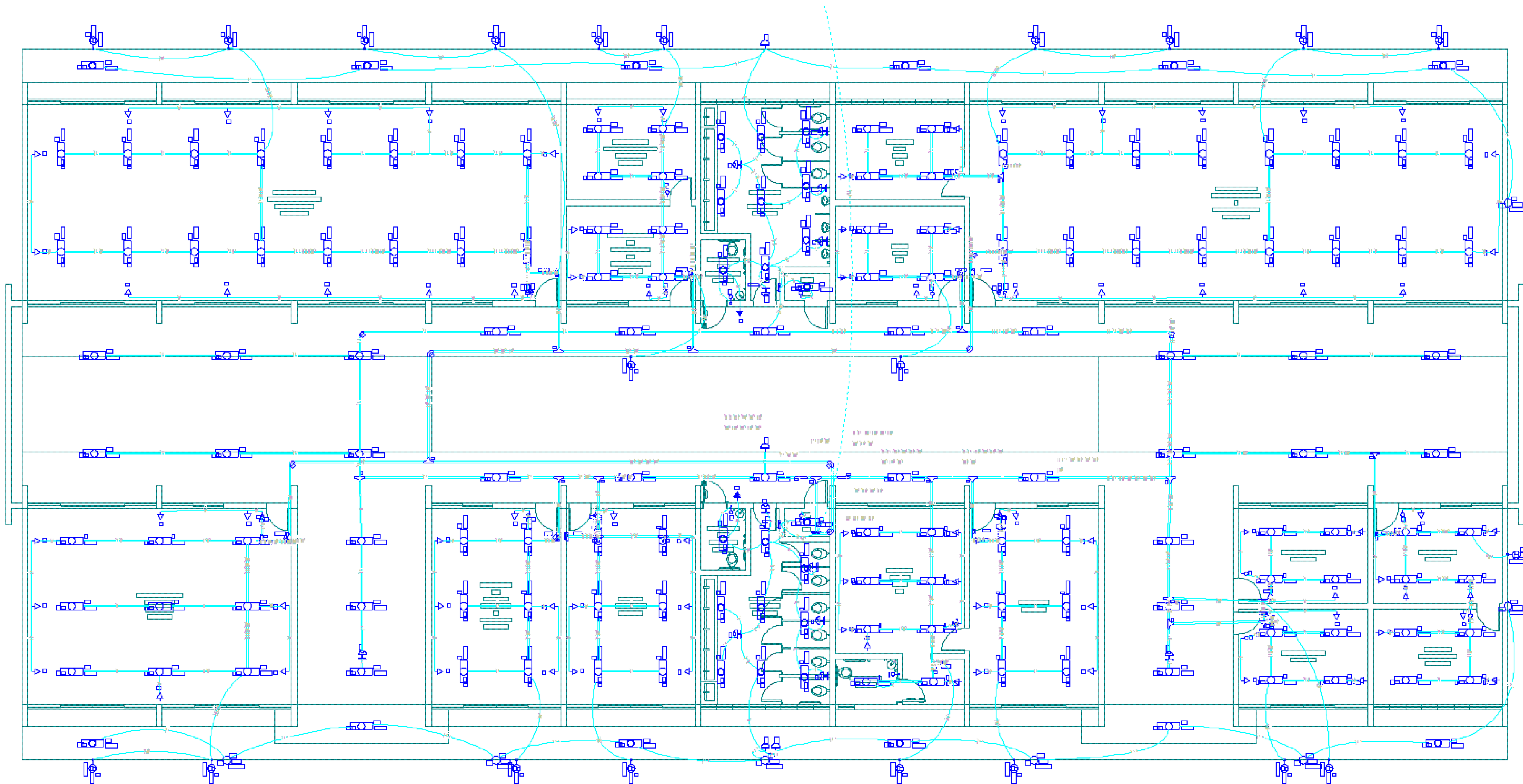

IFC CAMPUS MAFRA  
ANTEPROJETO  
ELÉTRICO  
BLOCO A - ADMINISTRATIVO  
PLANTA  
ESCALA: 1/50  
RUA 25 DE MARÇO, FAXINAL, MAFRA, SC  
ARQ. URB. MARCELO BRADACZ LOPES  
V00 - 05/07/2024

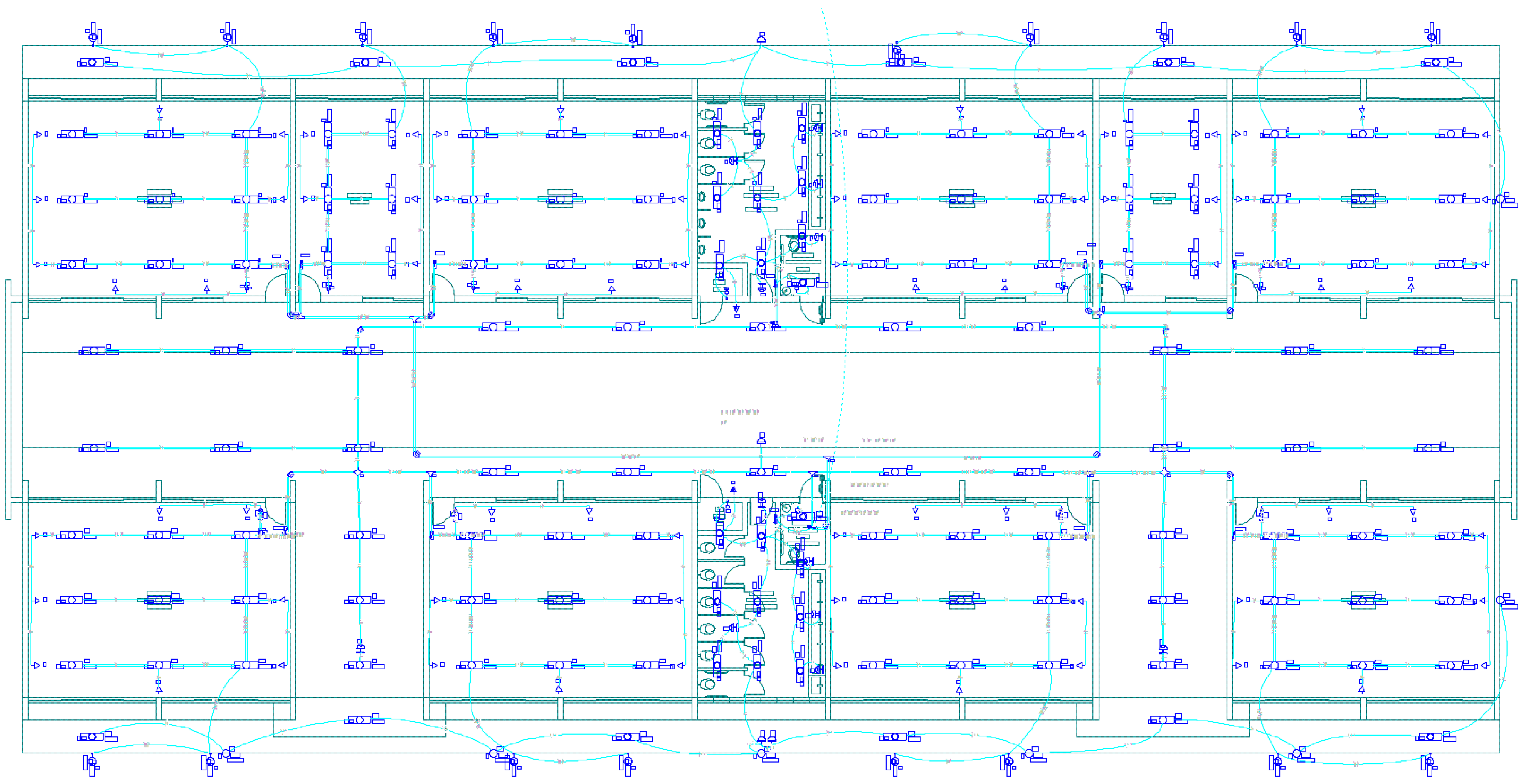

IFC CAMPUS MAFRA  
ANTEPROJETO  
ELÉTRICO  
BLOCO B - PROFESSORES  
PLANTA  
ESCALA: 1/50  
RUA 25 DE MARÇO, FAXINAL, MAFRA, SC  
ARQ. URB. MARCELO BRADACZ LOPES  
V00 - 05/07/2024

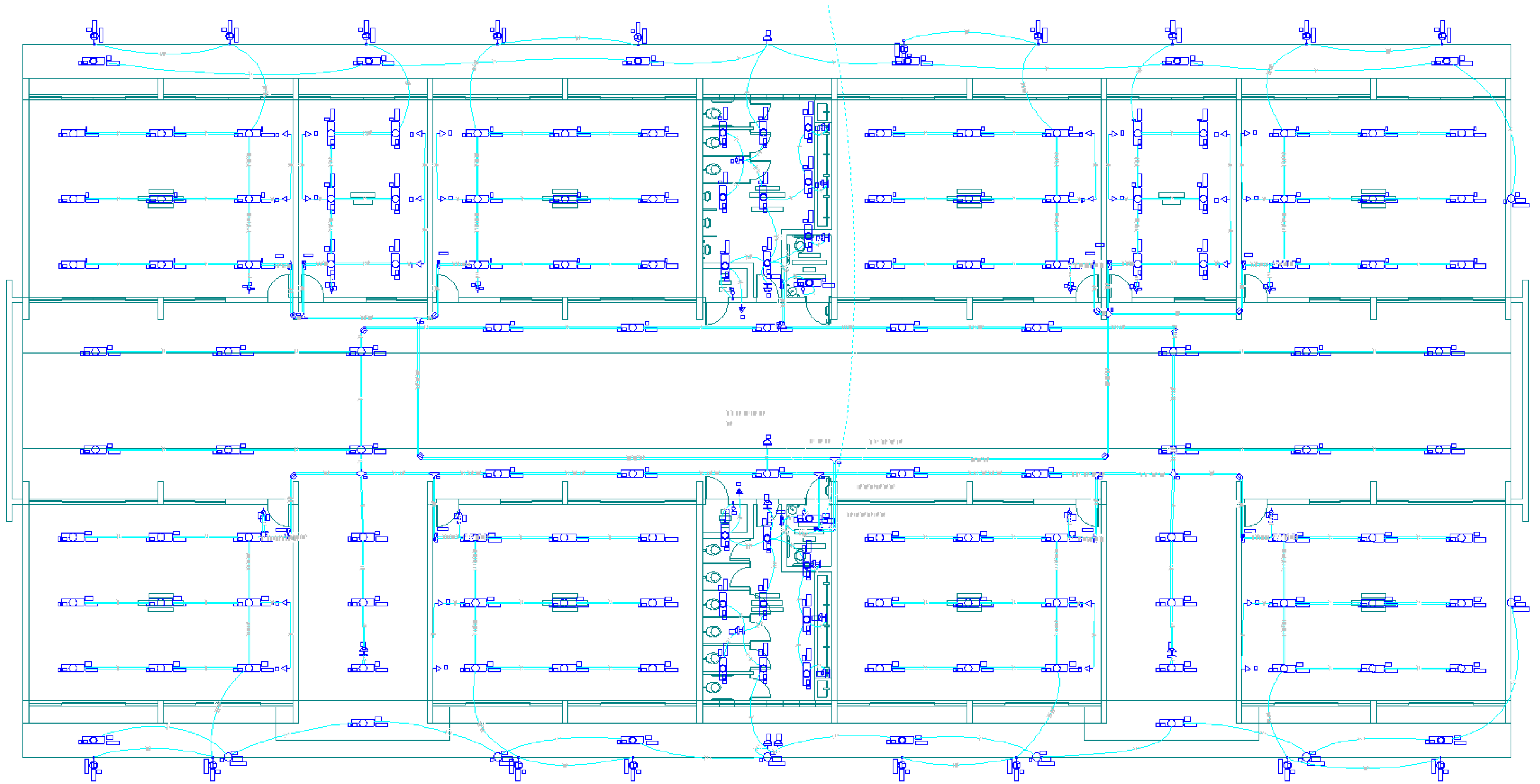

IFC CAMPUS MAFRA  
ANTEPROJETO  
ELÉTRICO  
BLOCO C - PEDAGÓGICO SALAS DE AULA  
PLANTA  
ESCALA: 1/50  
RUA 25 DE MARÇO, FAXINAL, MAFRA, SC  
ARQ. URB. MARCELO BRADACZ LOPES  
V00 - 05/07/2024

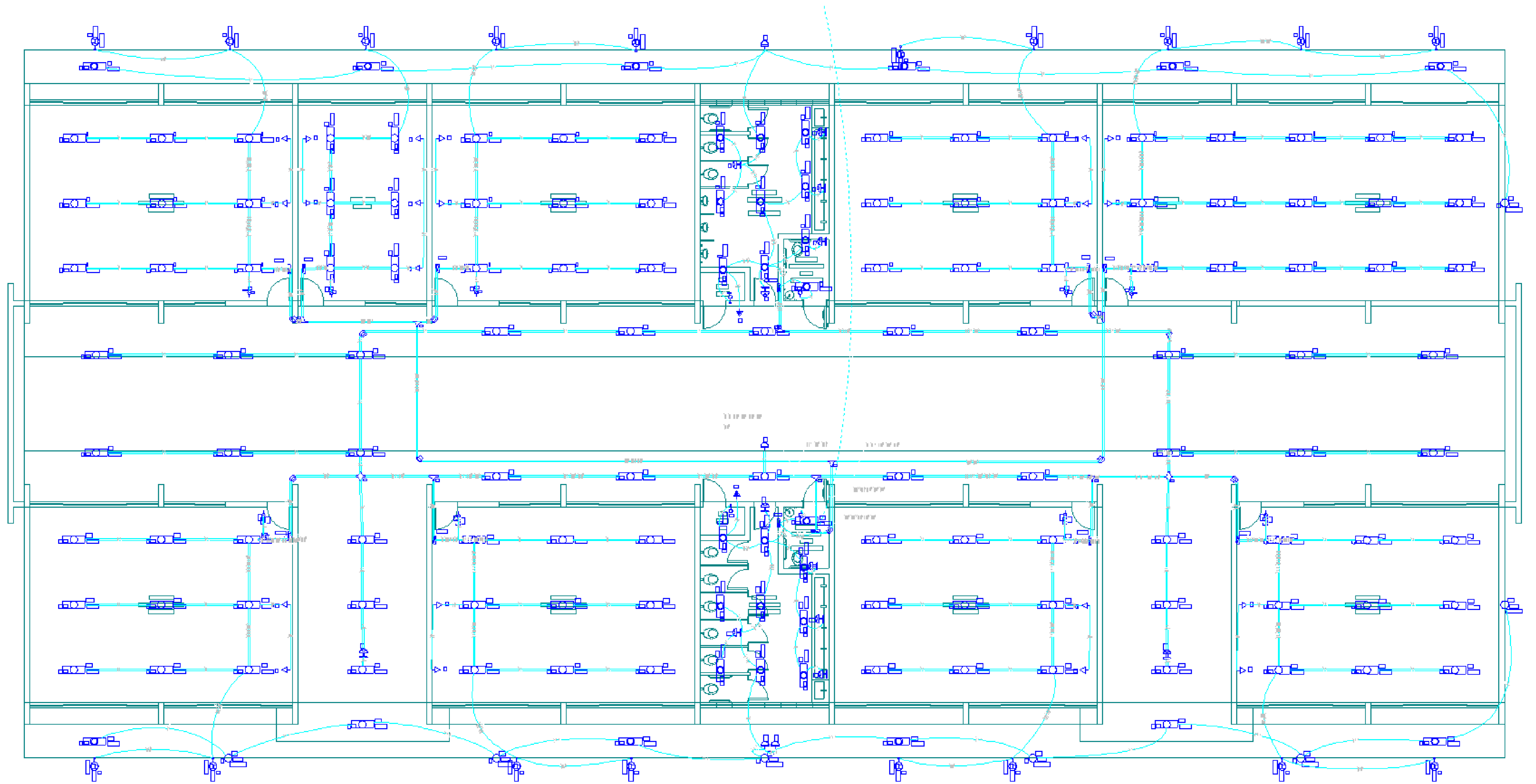

IFC CAMPUS MAFRA  
ANTEPROJETO  
ELÉTRICO  
BLOCO D - PEDAGÓGICO SALAS DE AULA  
PLANTA  
ESCALA: 1/50  
RUA 25 DE MARÇO, FAXINAL, MAFRA, SC  
ARQ. URB. MARCELO BRADACZ LOPES  
V00 - 05/07/2024



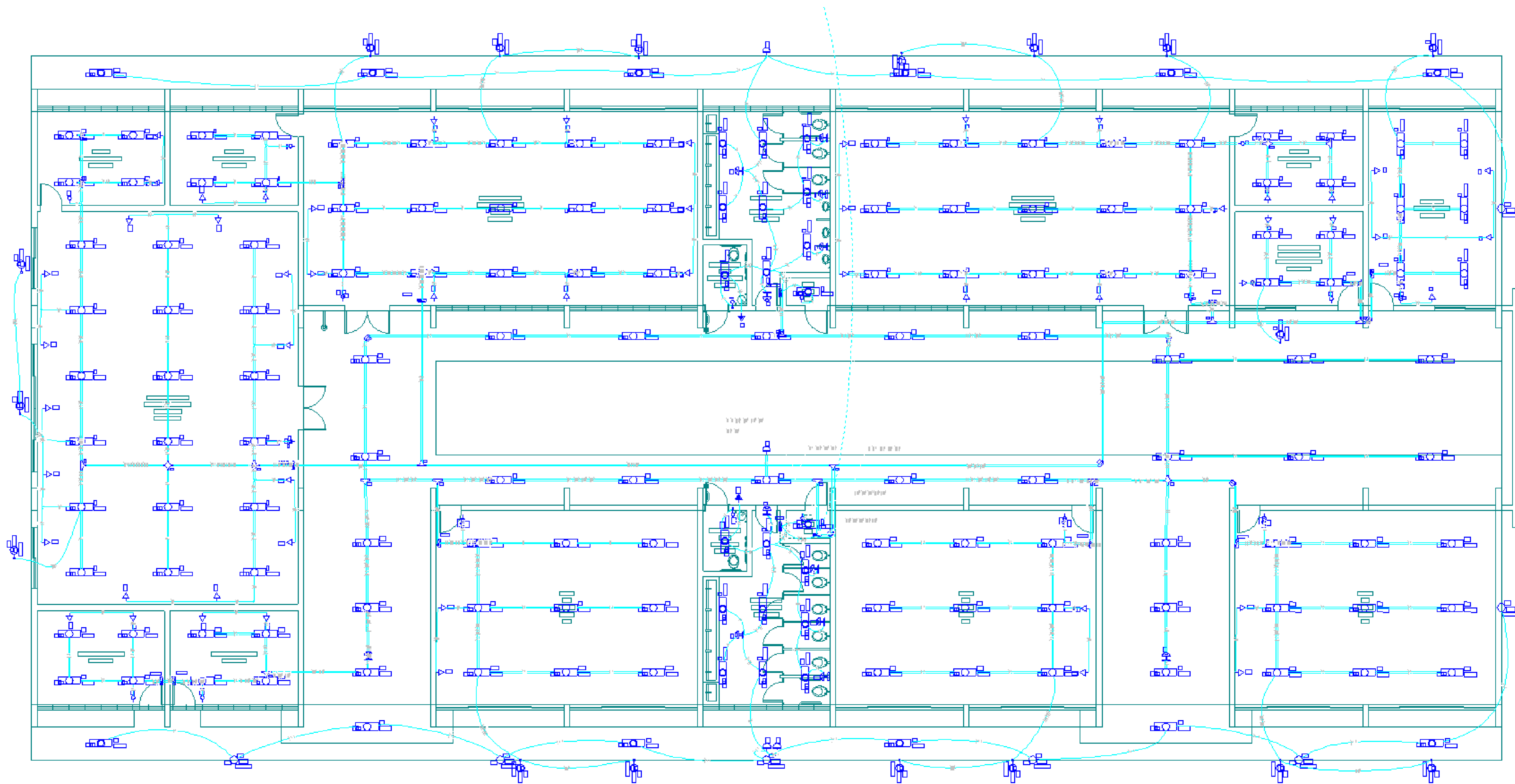

IFC CAMPUS MAFRA  
ANTEPROJETO  
ELÉTRICO  
BLOCO E - PEDAGÓGICO LABORATÓRIOS PROPEDEÚTICOS  
PLANTA  
ESCALA: 1/50  
RUA 25 DE MARÇO, FAXINAL, MAFRA, SC  
ARQ. URB. MARCELO BRADACZ LOPES  
V00 - 05/07/2024

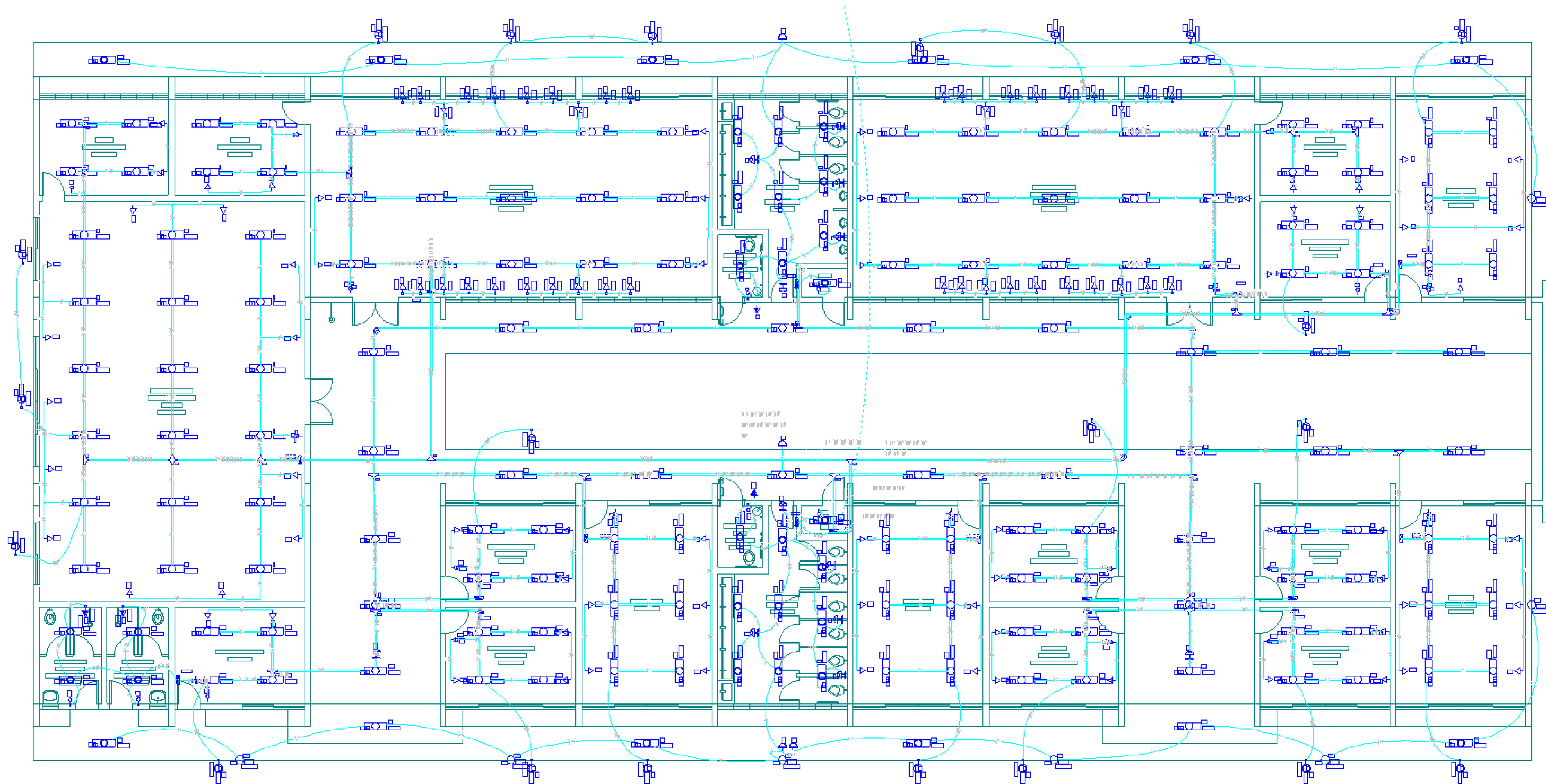

IFC CAMPUS MAFRA  
ANTEPROJETO  
ELÉTRICO  
BLOCO F - PEDAGÓGICO LABORATÓRIOS PROPEDEÚTICOS  
PLANTA  
ESCALA: 1/50  
RUA 25 DE MARÇO, FAXINAL, MAFRA, SC  
ARQ. URB. MARCELO BRADACZ LOPES  
V00 - 05/07/2024





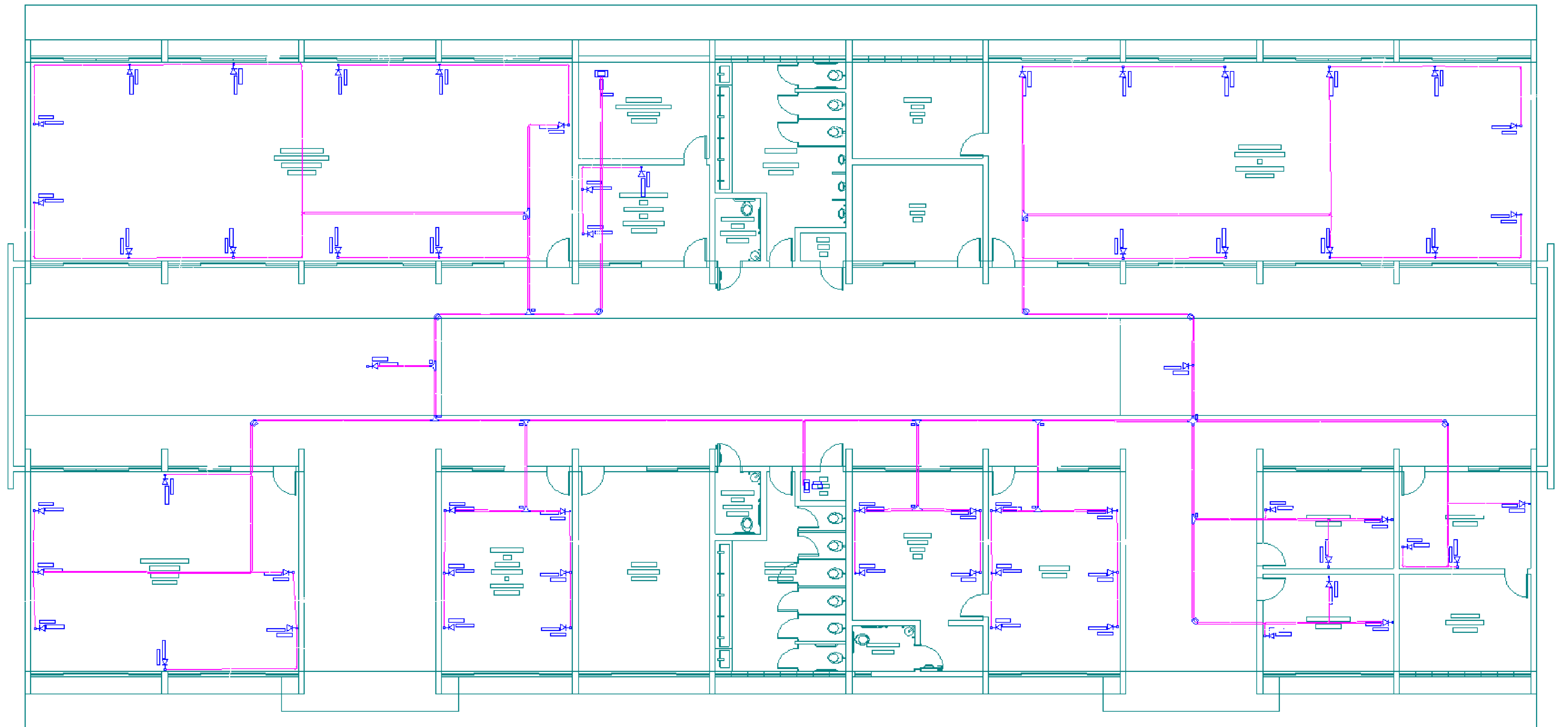

IFC CAMPUS MAFRA  
ANTEPROJETO  
LÓGICO  
BLOCO A - ADMINISTRATIVO  
PLANTA  
ESCALA: 1/50  
RUA 25 DE MARÇO, FAXINAL, MAFRA, SC  
ARQ. URB. MARCELO BRADACZ LOPES  
V00 - 05/07/2024

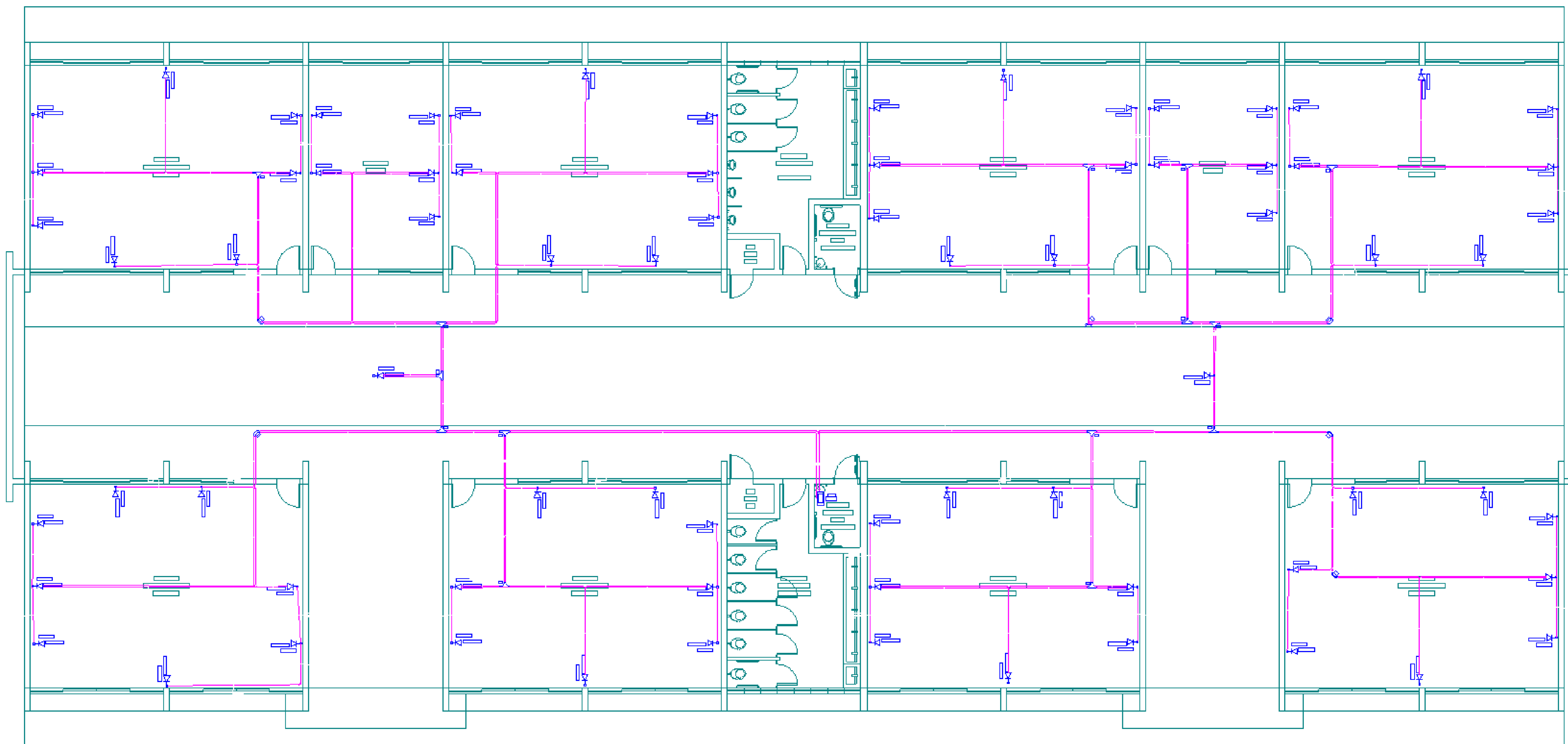

IFC CAMPUS MAFRA  
ANTEPROJETO  
LÓGICO  
BLOCO B - PROFESSORES  
PLANTA  
ESCALA: 1/50  
RUA 25 DE MARÇO, FAXINAL, MAFRA, SC  
ARQ. URB. MARCELO BRADACZ LOPES  
V00 - 05/07/2024

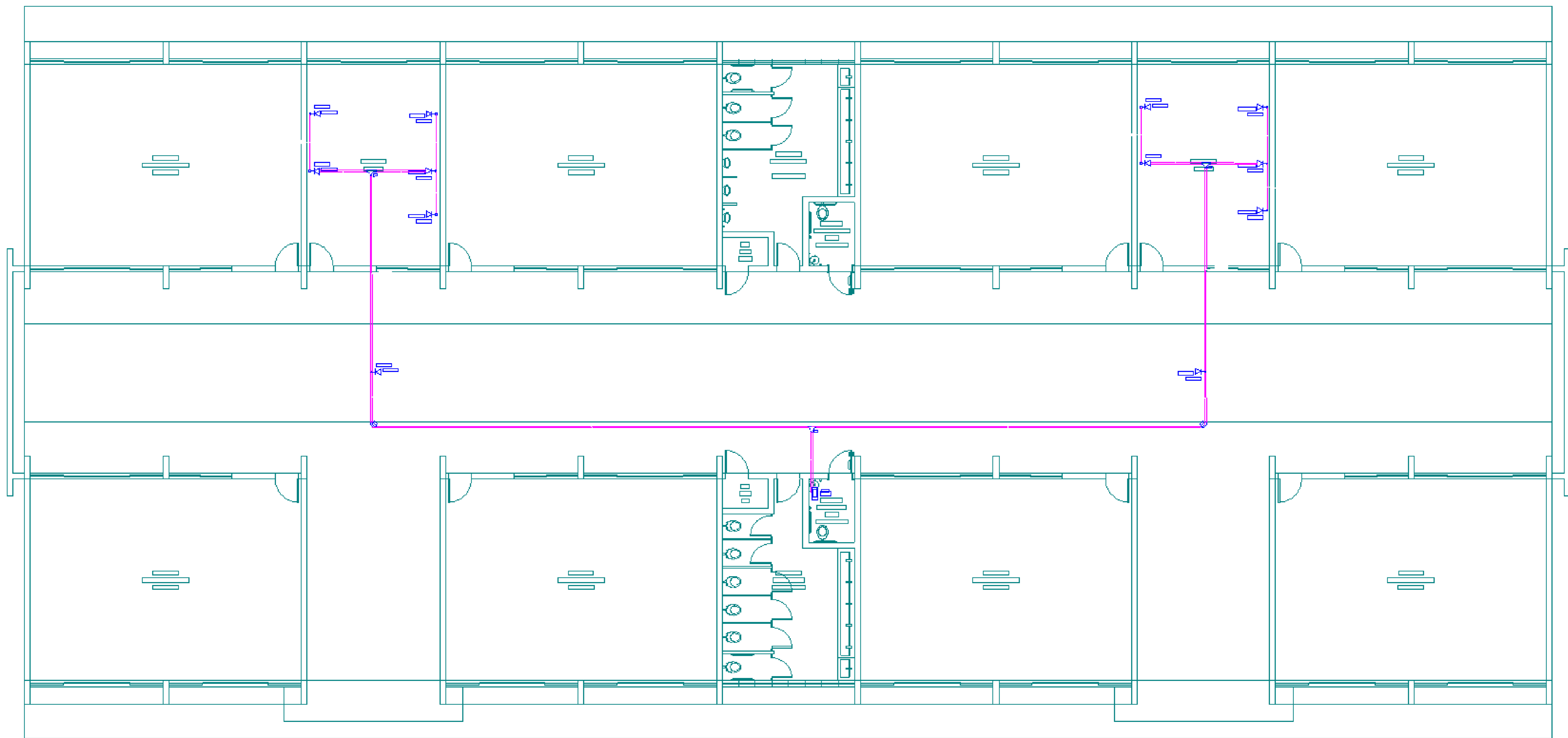

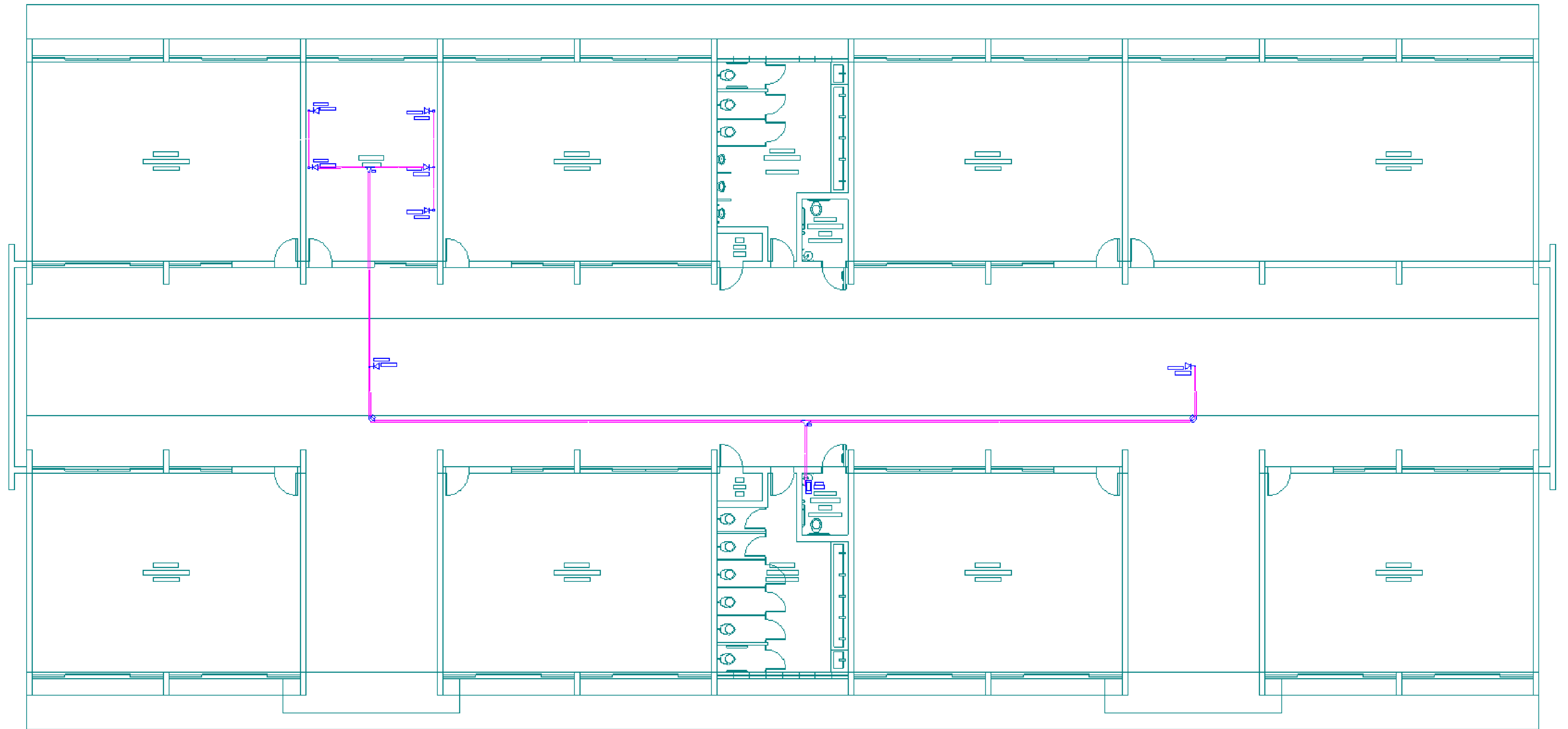

IFC CAMPUS MAFRA  
ANTEPROJETO  
LÓGICO  
BLOCO D - PEDAGÓGICO SALAS DE AULA  
PLANTA  
ESCALA: 1/50  
RUA 25 DE MARÇO, FAXINAL, MAFRA, SC  
ARQ. URB. MARCELO BRADACZ LOPES  
V00 - 05/07/2024



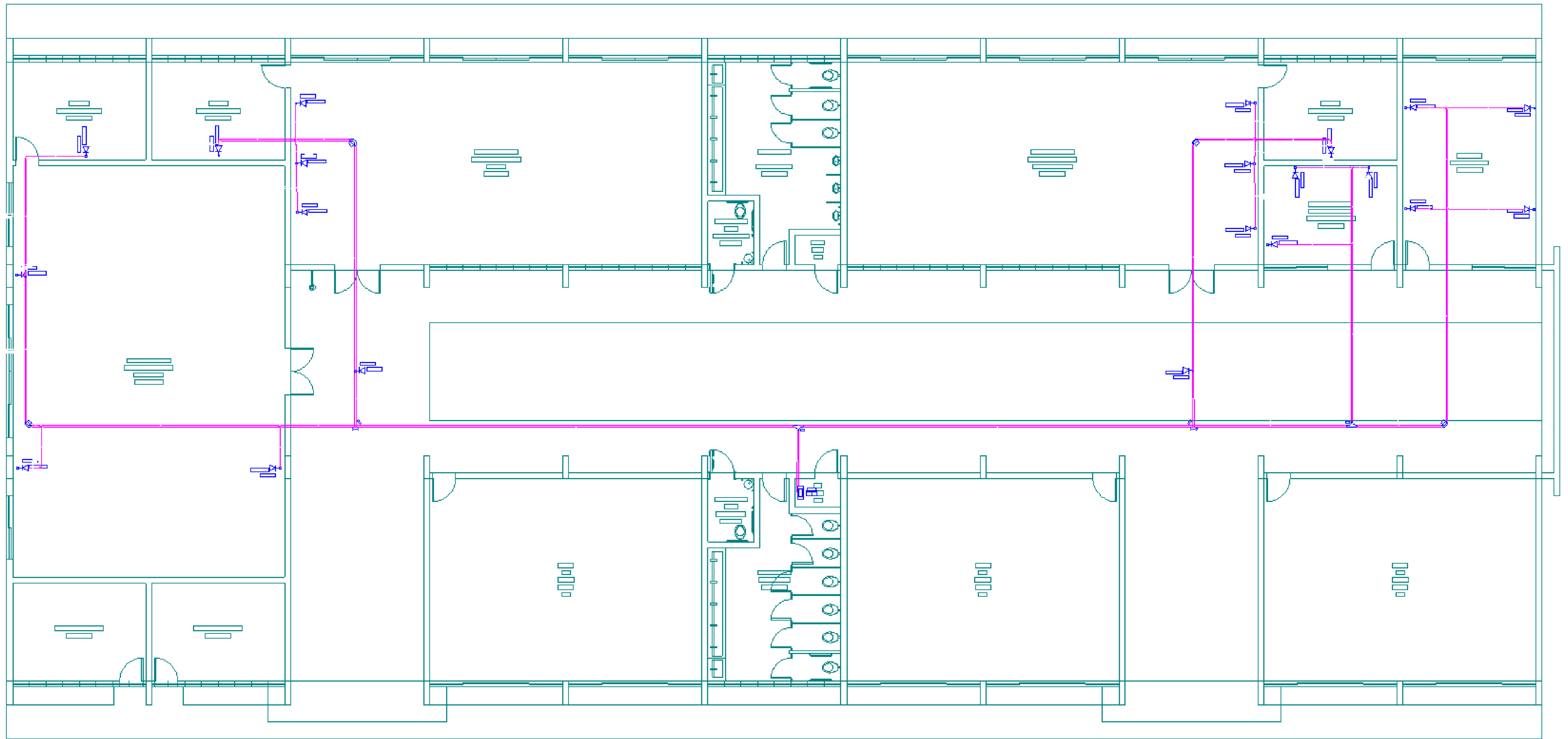

IFC CAMPUS MAFRA  
ANTEPROJETO  
LÓGICO  
BLOCO E - PEDAGÓGICO LABORATÓRIOS PROPEDEÚTICOS  
PLANTA  
ESCALA: 1/50  
RUA 25 DE MARÇO, FAXINAL, MAFRA, SC  
ARQ. URB. MARCELO BRADACZ LOPES  
V00 - 05/07/2024

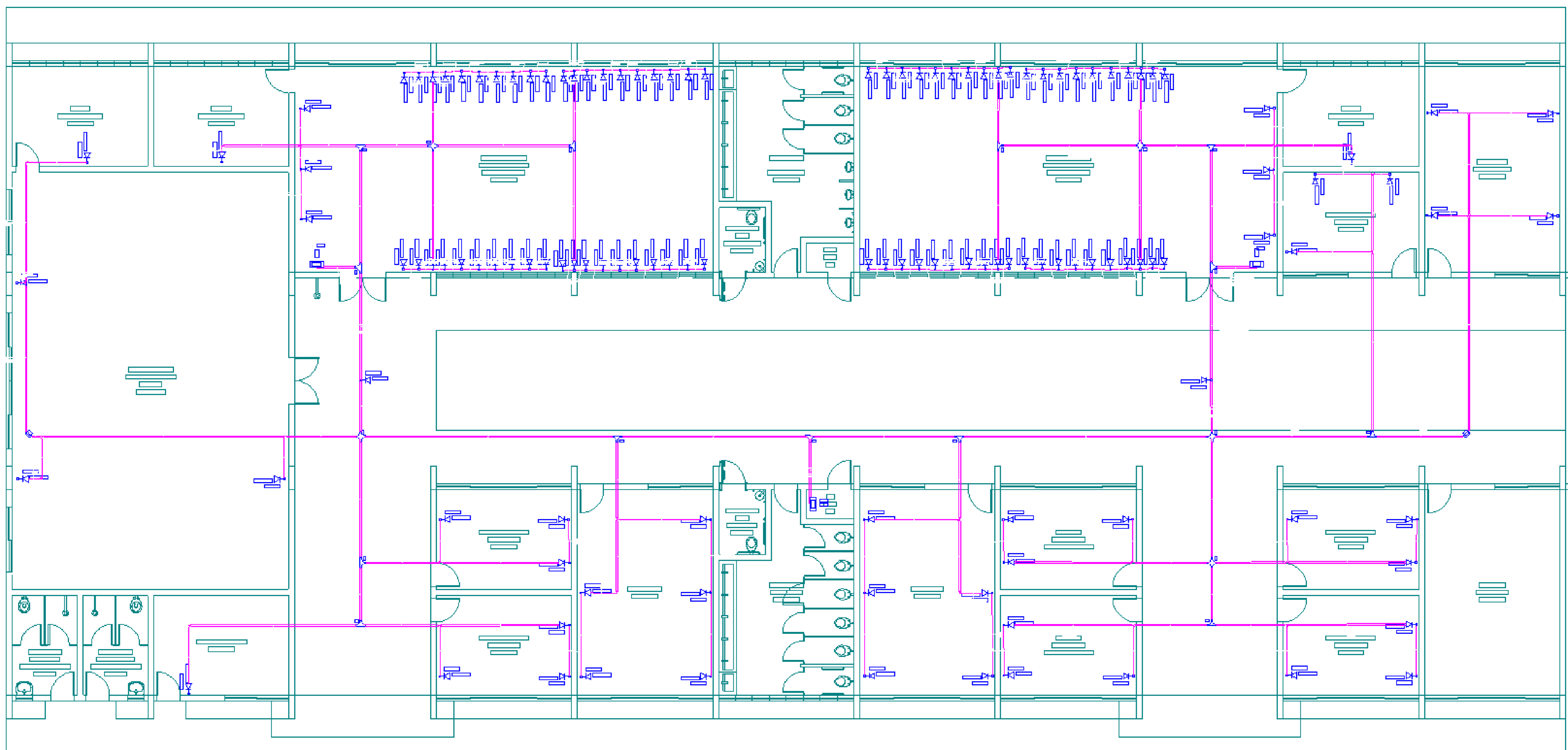

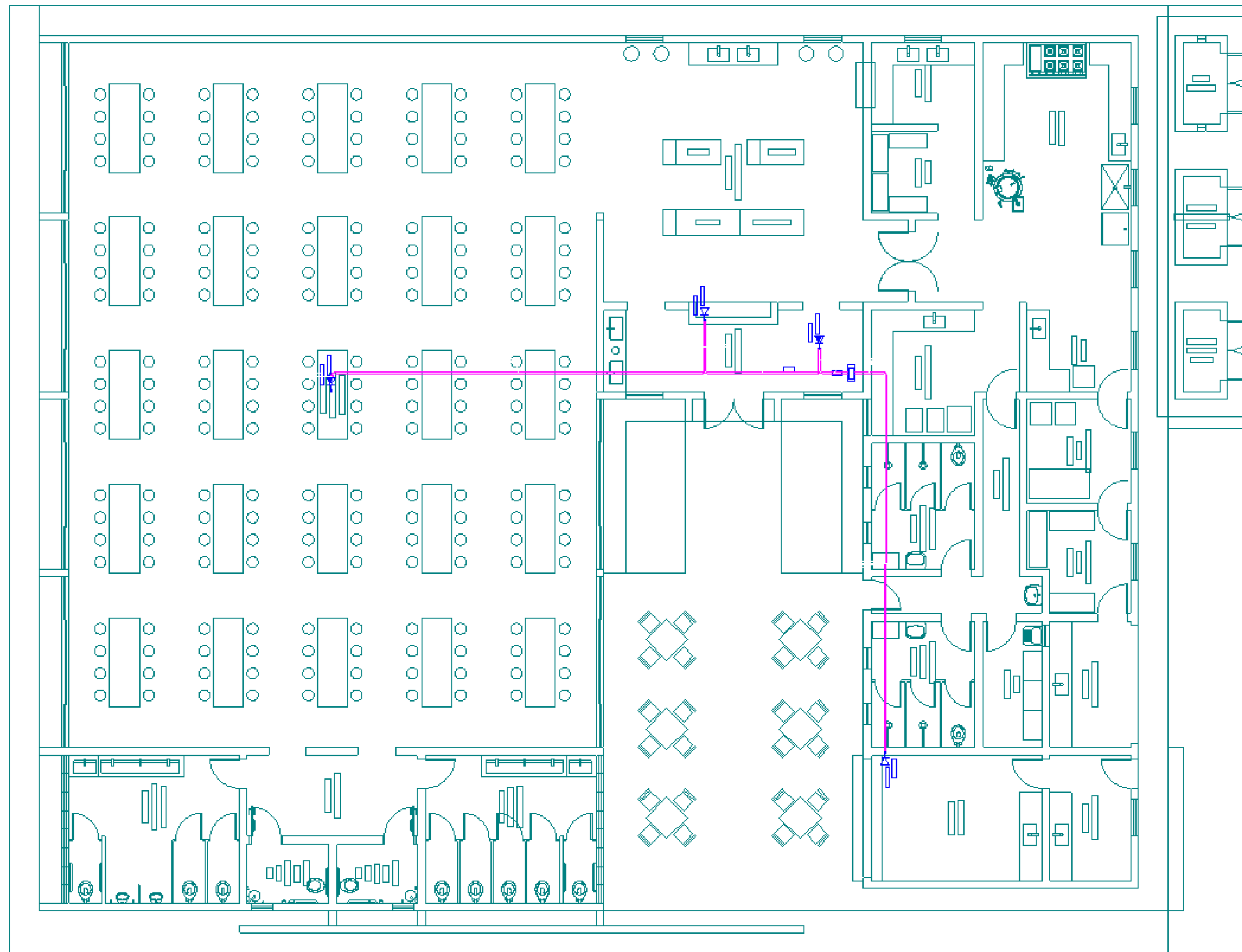

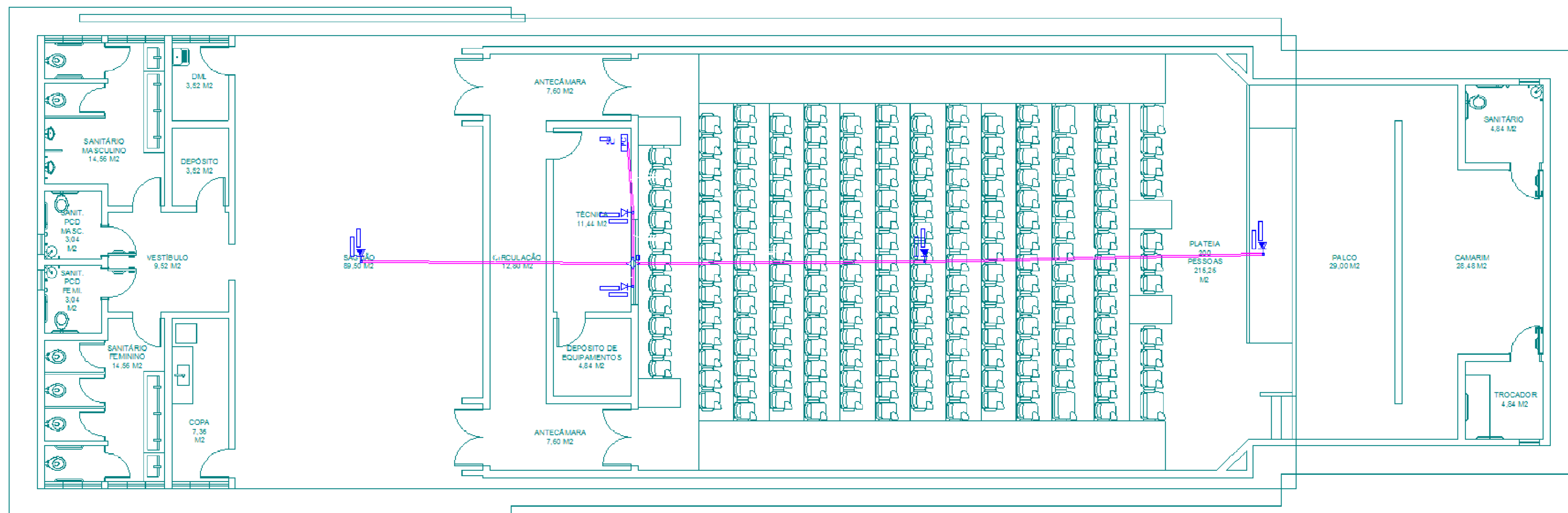
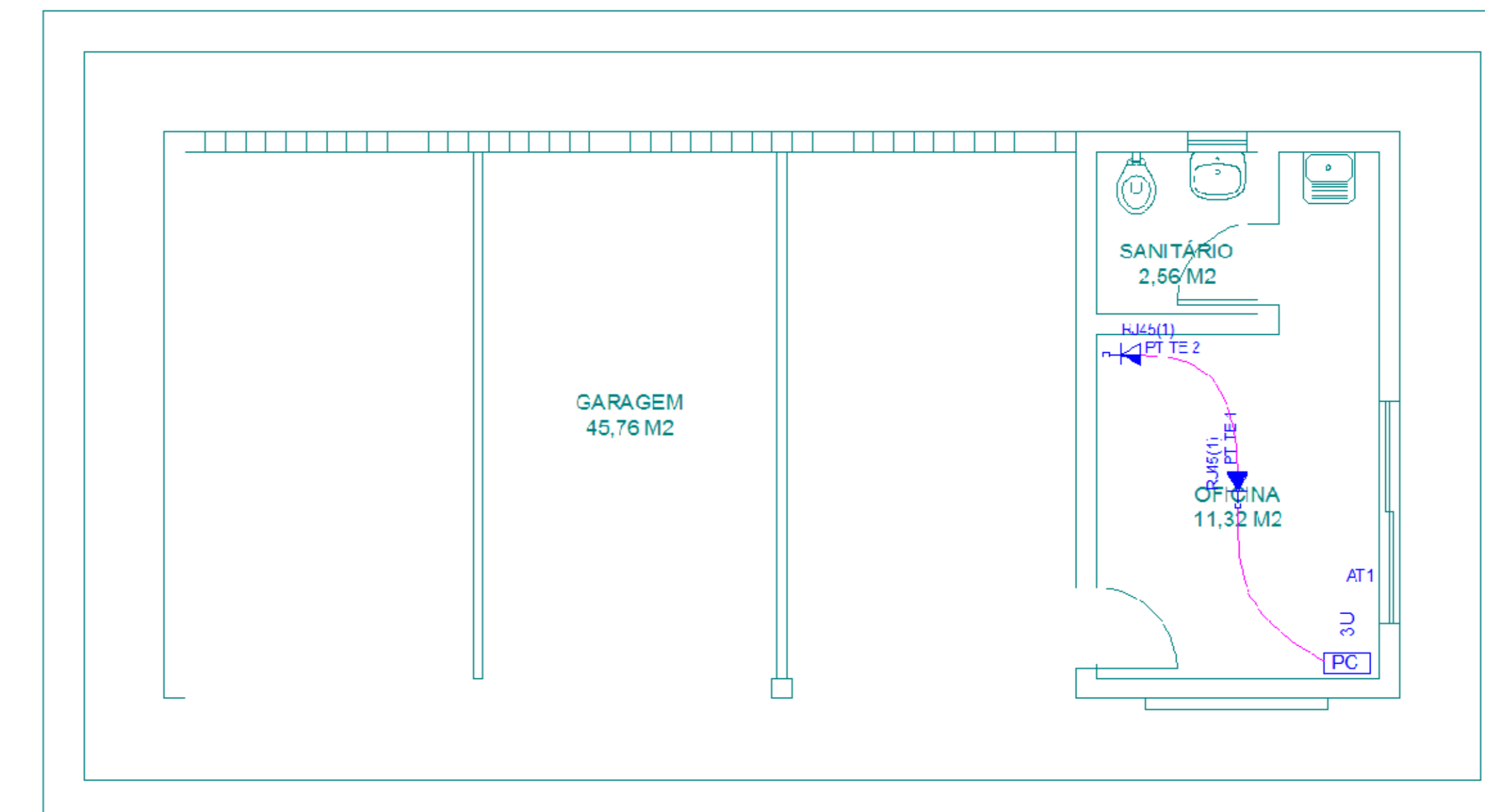
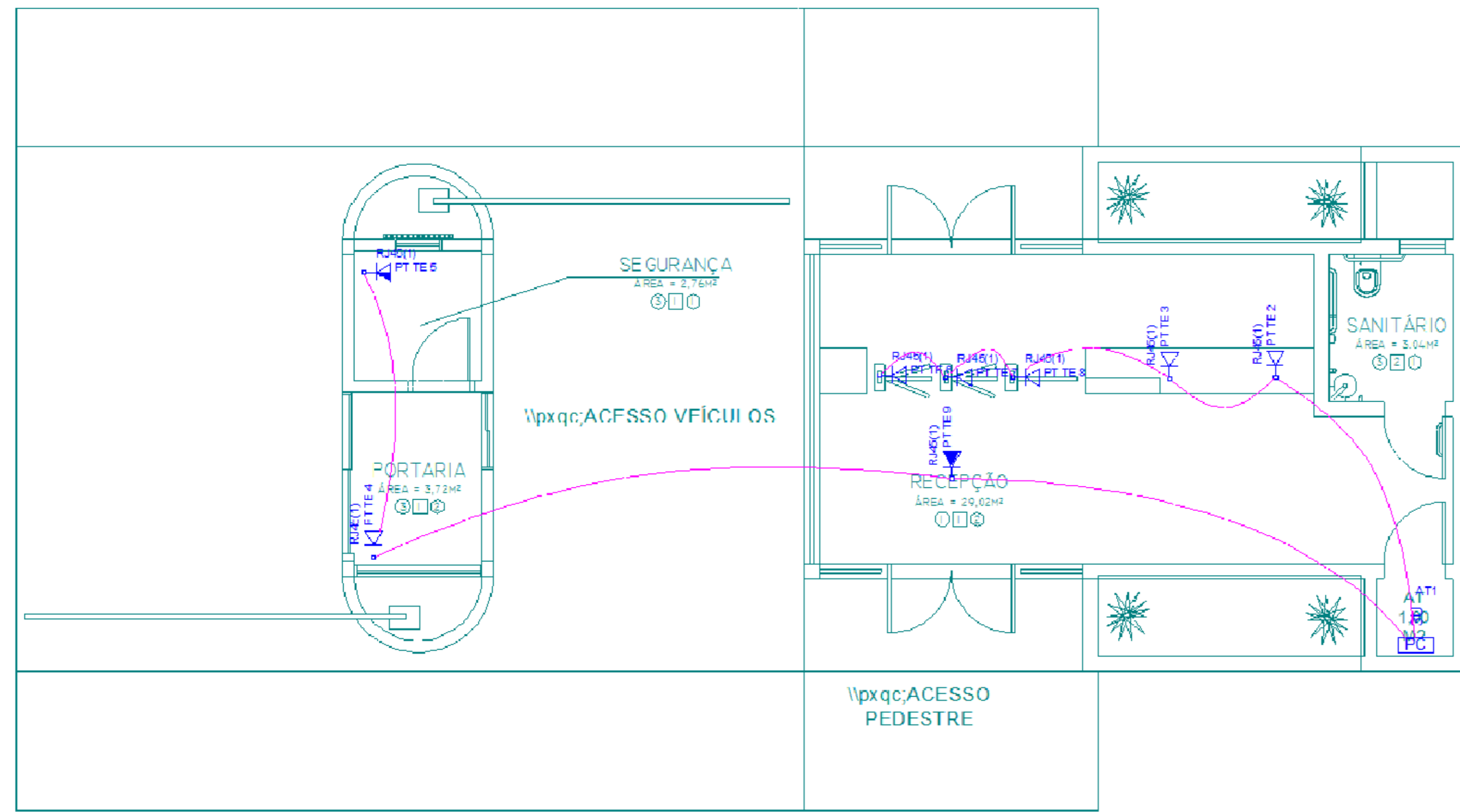

IFC CAMPUS MAFRA  
 ANTEPROJETO  
 LÓGICO  
 GUARITA/RECEPÇÃO, GARAGEM/OFICINA E AUDITÓRIO  
 PLANTA  
 ESCALA: 1/50  
 RUA 25 DE MARÇO, FAXINAL, MAFRA, SC  
 ARQ. URB. MARCELO BRADACZ LOPES  
 V00 - 05/07/2024